



Other Cutting Tools

Angle grinder Super System

A range of blades for use on an angle grinder. These blades are designed to be used with a special protective guard, which is also available from stock.

	D	B	b	c	z	£
Steel	125	2.2	1.6	25.4	24	77.68
	115	2.2	1.6	25.4	24	70.38
Wood	125	2.5	1.5	25.4	12	59.16
	115	2.5	1.5	25.4	12	54.26
Carver	125	4.0	2.5	25.4	6	60.78
	115	4.0	2.5	25.4	6	55.85
Guards	115/125					76.17

Router Cutters

2 Flute Plunge router cutters



Cutting Dia	Cutting Length	Shank Dia	Shank Length	£
A	B	C	D	
1/2"	2"	1/2"	35mm	23.25
1/2"	1.1/14"	1/2"	35mm	20.25

Mortice Chisel & bit Sets

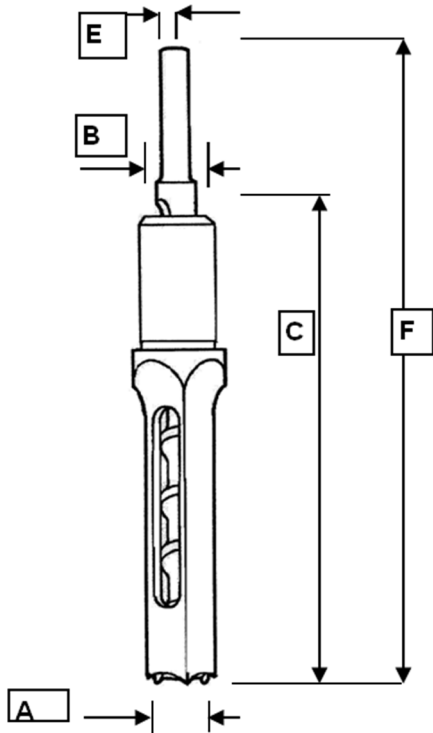

Size	A	B	C	E	F	£
1/4"		20.6	133	4.4	210	43.63
5/16"		20.6	138	5.9	210	43.63
3/8"		20.6	138	7.0	210	43.63
7/16"		20.6	138	8.4	210	47.68
1/2"		20.6	138	9.4	210	47.68
9/16"		20.6	156	10.5	225	55.34
5/8"		20.6	156	11.9	225	55.34
3/4"		20.6	163	11.9	240	79.25
1"		30.1	190	12.5	275	146.16

