

SWEDEX

SAW BLADES

CATALOGUE

2020/21

Made in Sweden



Contact information

Swedex (UK) Ltd
Unit 9, Brunel Park
Blyth Road
Harworth
Doncaster
South Yorkshire

Telephone 01302 759661
Fax 01302 751807
E-mail info@swedex.co.uk
Web Site www.swedex.co.uk

Company Registration No. 04638613

VAT Registration No. GB 808 7317 18

Table of contents

Sales and Company Information

Contact details & main index 1

Swedex Code System

Coding System & ordering information 2-3

Recommendation Diagram

Blade speed & cutting data 4

Saw Blades Numerical

Rip saw blades with wiper slots 5-6
Rip saw blades 7-8
Universal saw blades 9
Cross cut, trim & panel sizing blades 10-13
Negative saw blades for wood cutting 14
Edgebanding, nail resistant & splitter planning 15
Special saw blades for wood & paper cutting 16
Panel sizing blades for wall saws 17
Panel sizing blades (Wide kerf) 18
Scoring/scribing blades 19
Tenoner scoring blades & hoggers 20
Groove cutting blades & Biscuit Jointers 21
Moulders 22
Non-ferrous metals & plastics 23-26
Special blades for the window/UPVC industry 27-28
Steel cutting blades 29
Sawmill industry – Information 30
Other:
HSS saw blades(GLG Brand) 31
Portable Saws (Hobby blades-Nuco Brand) 32
Mortice Chisel & bit sets and Router Cutters(Nuco Brand) 33

Saw Blades A-Z

Aluminium & plastic cutting 23-25
Biscuit Jointers 21
Cross cut, trim & panel sizing 10-13
Groovers 21
Hoggers 20
Nail resistant 15
Negative for wood 14
Moulders 22
Non-ferrous & plastic 23-26
Panel sizing 17-18
Ripping 5-8
Sawmill Information 30
Scoring/scribing 19
Specials – Window/UPVC 27-28
Specials – Wood 16
Splitter/planers 15
Steel 29
Tenoners 20
Universal blades 9
Other:
HSS (GLG Brand) 31
Portable saw(Hobby blades -Nuco Brand) 32
Mortice Chisel & bit sets & Router Cutters(Nuco Brand) 33

Page

1

Code system

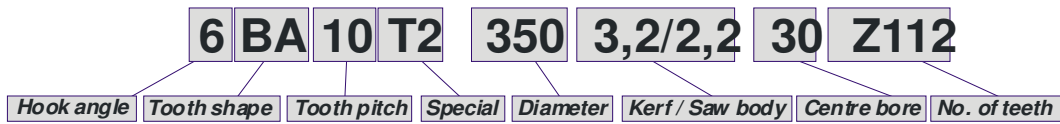

Swedex code system specifies the composition of the saw blade

- First the hook angle is specified, in this example 6 degrees.
- Negative hook angle is indicated by N, e.g. N2.
- Tooth shape is specified by two or three letters.
- Tooth pitch is the distance between two adjacent teeth.
- Special indicates different features of the saw blade, e.g. T2 states that the saw blade has smaller kerf and SP states that it is a special saw blade.
- Thereafter the diameter is specified (in mm like the other measures).
- Kerf is the width of the TCT tooth.
- Saw body is the thickness of the steel body.
- The centre bore is specified with the general tolerance H7
- No. of teeth is always written after the letter z.

In this catalogue we use the following abbreviations: diameter (D), kerf (B), saw body (b), centre bore (c), no. of teeth (z), wiper slots (RS)

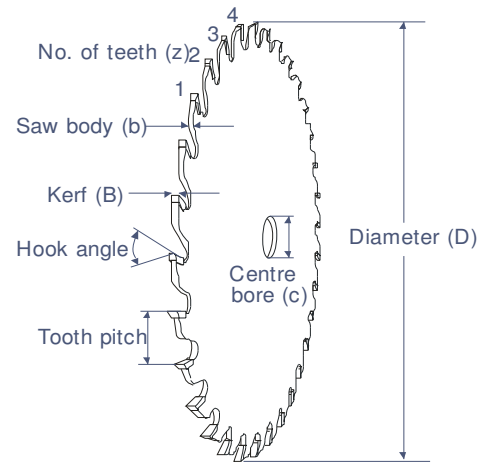

HOOK ANGLE

The hook angle depends on the material, type of cutting and machine type. Some general hook angles for a range of materials are shown below.

Negative 5-10° - crosscutting of wood in pendulum and parallel saws, edge band cutting and trimmer machines using with feed.



Negative 2-5° - cutting of metals with manual feed, plastics and laminates.



6-10° - crosscutting of wood, hard plastics and veneered and laminated boards. Metal sawing with automatic feed.



5-15° - crosscutting of wood. Panel sizing of chipboards, plastics, plywood and veneered boards.



22° - ripping of dry or green wood.



25-30° - ripping and edging of green wood.

TOOTH SHAPE

Tooth shape indicates what kind of top grinding the saw blade has. Here the most common types are shown. Although there are several other types and combinations than the ones listed below.

AA. Straight teeth

For ripping wood, including multirip sawing. Can be used with high feed speeds where an average surface finish is required.



BA. Alternately beveled teeth

For ripping and crosscutting wood. Panel size sawing, e.g. of plywood. Gives good finish.



BAE. Alternately beveled teeth with chamfer

For sawing of thin and hard plastics.



CA. Right hand beveled teeth

DA. Left hand beveled teeth
All teeth are beveled in the same direction. Gives good finish. Used for pre-sawing, scribing, tenoning, and panel sizing.



EA. Trapezoidal teeth

Roughing and finishing teeth. For sawing of coated and non-coated woodblocks e.g. chip-, fibre-, MDF- and HDF-boards. Also suitable for plastic and laminated boards.



EAM. Trapezoidal teeth

EAM for sawing of metal.

RA. Straight teeth with conical sides

Used as a scribing saw blade when fractioning boards, prior to panel sizing.

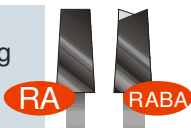

RABA. Alternately beveled teeth with conical sides

EAXH. Alternately straight and inverted V tooth, with hollow ground front

For sawing of varnished and coated boards.



TOOTH PITCH

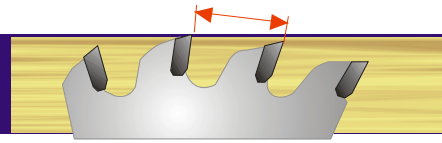

Tooth pitch is an important factor when choosing blades for different types of work. The pitch is the distance between the front faces of adjacent teeth and is given in mm. The formula to the right can be used for calculating the tooth pitch.

$$\text{Tooth pitch} = \frac{\text{Diameter} * \pi}{\text{No. of teeth}}$$

FRONT GRIND

The front of the tooth is straight as standard. To get maximum sharpness and the best cutting performance the teeth can also be alternately beveled or hollow ground.

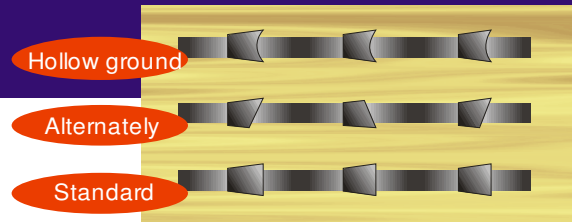

KEYWAYS & SCREW/PIN HOLES

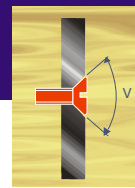

Screw- and pin holes

Screw holes (FH) and pin holes (PH) are specified by the pitch circle (DC) or "edge to edge" (kk), as shown in the picture to the right.

Example:
2PH6DC80
2PH6kk7
(D=60mm, d=6mm,
DC=80mm)

When ordering screw holes always state the side of the countersink. Hold the saw blade with the teeth on the top faced towards you as shown in the picture below. The picture shows a right countersink.

NOTE: If the sawblade only has one pin hole specify "centre / centre" distance between D and d.

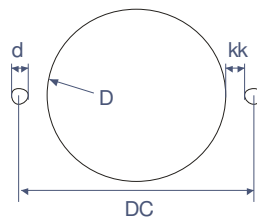

For screw holes state Di and the countersunk angle or Dy or screw type (ex. M5). Furthermore, DC should always be stated.

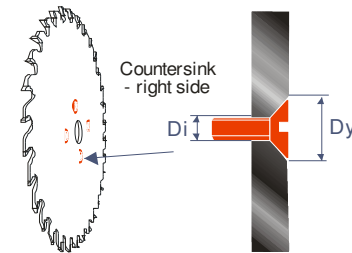

Keyways

When ordering keyways state information about width (x), depth (y) and number of keyways.

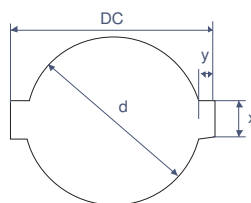

Example:

A blade has 2 keyways with width 11mm and depth 6mm.
2ks11 x6

Example:

A blade has 4 screw holes, with inner diameter Di=6,0mm, outer diameter Dy=10,0mm and DC=80mm. The countersink is on the right side.
4FH 6,0 Dy=10,0 DC=80 countersink right

$$y = \frac{DC - d}{2}$$

SPECIAL

After tooth pitch "special" is stated. In the table below some common special saw blades are listed. If the saw blade is totally customised the note "sp" is stated.

- B2 = Large kerf
- T2 = Small kerf
- T3 = Extra small kerf
- T4 = Extra small kerf (with limited cutting depth)
- S = Blade with guard teeth
- R = Wiper slot blade
- SR = Wiper slot blade with guard teeth
- E = Reduced gullet for noise reduction
- L = Laser dampened saw body
- BO = Bombastic side grinding

When ordering special saw blades a drawing should if possible be enclosed. If not, please provide the following information:

1. Type of machine
2. Speed (rpm)
3. Feed speed (m/min)
4. Diameter
5. Centre bore
6. Flange diameter
7. Keyways, pin holes, screw holes
8. Wiper slots, open or closed
9. Chip limiter
10. Material to be cut (green or dry)
11. Saw height (mm/blade)
12. Type of cutting edge

INQUIRY SPECIAL SAW BLADE		SWEDEX SAW TOOLS	
<p><small>This form helps us to optimise the correct saw blade for your saw application. You do not need to fill in all lines, but the more information we receive, the better possibility we have to make a good solution for you.</small></p>			
<p>BASIC FACTS</p> <p>Are the serial no. of the previously saw blade known?</p> <p>Is: 22841771 2023,67 21238 or serial no. _____</p> <p>Diameter: _____ mm (tolerance: _____)</p> <p>Kerf: _____ mm (tolerance: _____)</p> <p>Note: _____ mm (tolerance: _____)</p>		<p>Customer: _____</p> <p>Address: _____</p> <p>Contact person: _____</p> <p>Phone: _____</p>	
<p>Keyways: no. _____ pcs Width(x): _____ Depth(y): _____</p> <p>Pin holes, no. _____ pcs Diameter (d): _____ mm</p> <p>PC: _____ mm or Edge to Edge (kk): _____ mm</p> <p>(When countersink also state side)</p> <p>Countersink diameter: _____ mm or</p> <p>Type of screw: _____ (in M5)</p> <p>Countersink side: Left <input type="checkbox"/> Right <input type="checkbox"/></p>		<p><small>When counter holes are required, the hole to be countersunk (left or right side of body) is identified with the label field to the right of the sketch. The picture shows the right hand side of the application.</small></p>	
<p>IF MORE SAW BLADE INFORMATION IS KNOWN</p> <p>Teeth shape: <input type="checkbox"/> Flat <input type="checkbox"/> Convex <input type="checkbox"/> Concave <input type="checkbox"/> Serrated <input type="checkbox"/> Other _____</p> <p>No. of teeth: _____ pcs H&L size: _____ HV <input type="checkbox"/> S&L size: _____</p> <p>Flare: Straight <input type="checkbox"/> Alternate <input type="checkbox"/> Hollow <input type="checkbox"/></p> <p>Wiper slots: _____</p> <p>Outside no. _____ pcs Length: _____ mm</p> <p>Inner no. _____ pcs Length: _____ mm PC: _____ mm</p> <p>Saw body thickness: _____ mm</p> <p>Sound reduction (back-cut): <input type="checkbox"/> No <input type="checkbox"/> Yes <input type="checkbox"/></p> <p>Type of slot: <input type="checkbox"/> Standard <input type="checkbox"/> Limbor <input type="checkbox"/> Other _____</p> <p>Hub thickness: _____ mm Hub diameter: _____ mm</p> <p>Right <input type="checkbox"/> Left <input type="checkbox"/> Centre <input type="checkbox"/></p>			
<p>WORKPIECE MATERIAL</p> <p>Material: _____ quality</p> <p>Cutting direction: with lead <input type="checkbox"/> Against lead <input type="checkbox"/></p> <p>Saw one piece at time <input type="checkbox"/> Continuous sawing <input type="checkbox"/></p> <p>Saw height: _____ mm Dry wood <input type="checkbox"/> Green wood <input type="checkbox"/></p> <p>Saw quality: Rough <input type="checkbox"/> Medium <input type="checkbox"/> Fine <input type="checkbox"/> Ultra fine <input type="checkbox"/></p> <p>For solid wood, across grain <input type="checkbox"/> Along grain <input type="checkbox"/></p>		<p>MACHINE DATA</p> <p>Machine manufacturer: _____</p> <p>Machine type: _____</p> <p>Machine model: _____</p> <p>Flange diam: _____ mm</p> <p>Revolutions: _____ rpm Feed rate: _____ mm/min</p> <p>Manual Feed <input type="checkbox"/> Automatic feed <input type="checkbox"/></p> <p>Motorpower: _____ kW (or HP)</p>	

Download "Inquiry special saw blade" at: www.swedex.com

CUTTING SPEED

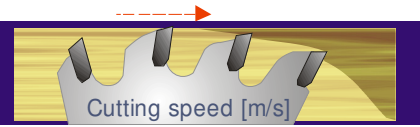

Generally you should choose a blade with the smallest diameter possible (to maximize the stability) and the smallest kerf possible. At the same time the diameter must be adapted to the machine's speed of revolution to receive the most suitable cutting speed (if the speed of the machine is non-adjustable).

Carbide tipped saw blades require relatively high cutting speeds. The recommended speed for working in wood-based materials is about 70 m/sec.

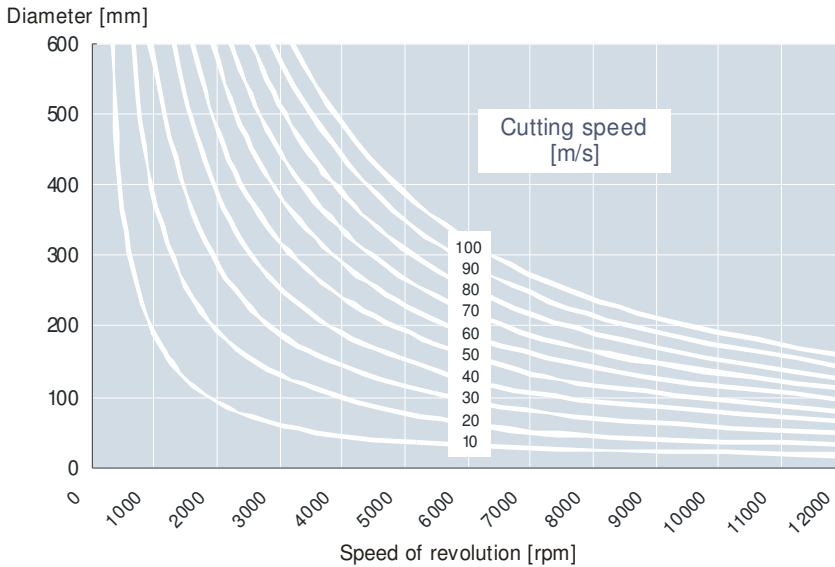

$$\text{Cutting speed} = \frac{\text{Diameter} * \text{RPM} * \pi}{60 * 1000}$$

$$[\text{M/sec}] = \frac{[\text{mm}] * [\text{rpm}] * \pi}{60 * 1000}$$

Material	Cutting speed [m/sec]
Wood: cross-cutting	50-80
ripping dry	60-100
ripping green	60-100
saw mill	60-100
Veneered and laminated board	60-80
Fibre board	70-80
Plaster- and chipboard, plywood	50-80
Veneers, cardboard rolls (tubes)	50-80
Hard plastic	50-75
Plexiglas, PVC, bakelite	50-85
Plastic laminates	50-75
Soft plastics	15-50
Aluminium	60-80
Copper	50-70
Brass	50-70
Light concrete	40-60
Steel (not hardened - mild)	5-30

FEED PER TOOTH

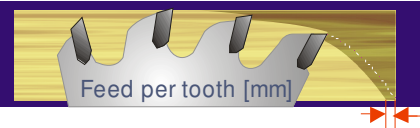

To optimize the saw blade's service life and cutting performance the usage of a correct feed per tooth is required. Too low feed speed cause rapid wear of the cutting edge. Too fast feed speed on the other hand could cause teeth to break (as a result of lacking chip pocket volume).

The table shows the recommended feed per tooth for different materials.

You can calculate the feed per tooth using the formula below.

$$\text{Feed per tooth} = \frac{\text{Feed speed} * 1000}{\text{Speed of revolution} * \text{no. of teeth}}$$

$$[\text{mm}] = \frac{[\text{m/min}] * 1000}{[\text{rpm}] * z}$$

Material	Feed per tooth [mm]
Wood: cross-cutting	0,10-0,35
ripping dry	0,10-0,20
ripping green	0,20-0,80
saw mill	0,70-1,50
saw mill*	0,80-2,50
Veneered and laminated board	0,05-0,12
Fibre board	0,08-0,25
Plaster- and chipboard, plywood	0,08-0,25
Veneers, cardboard rolls (tubes)	0,08-0,25
Hard plastic	0,05-0,12
Plexiglas, PVC, bakelite	0,05-0,12
Plastic laminates	0,03-0,06
Soft plastics	0,05-0,08
Aluminium	0,02-0,05
Copper	0,03-0,08
Brass	0,03-0,08
Steel (not hardened - mild)	0,01-0,03

GULLET FEED INDEX

If the feed per tooth is very high the gullet volume needs to be calculated. A small gullet volume leads to an increased risk of cracks. We have developed a Microsoft Excel program for calculating the gullet volume along with other saw data. Contact Swedex technical sales people or one of Swedex resellers for assistance.

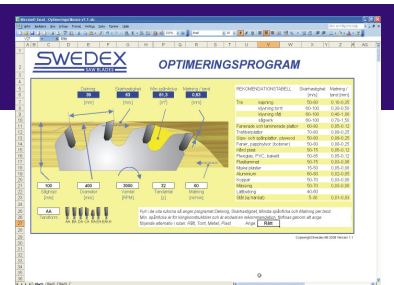



Rip Saw Blades with Wiper Slots

22AA46SR

With guard teeth and wiper slots. Diameter 180 to 200mm

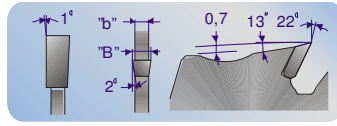

D	B	b	z	£
180	2.8	1.9	12+2	124.92
200	2.8	1.9	14+2	124.92
225	3.2	2.2	16+2	124.92
250	3.2	2.2	16+2	125.84
280	3.2	2.2	18+2	132.42
300	3.2	2.2	20+2	140.25
315	3.2	2.2	20+2	143.59
350	3.5	2.5	24+2	156.50
400	3.5	2.5	28+2	176.32

22AA46R

With large gullets and wiper slots. Diameter 225 to 400mm

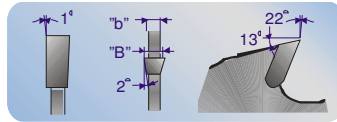

22AA39SR

With guard teeth and wiper slots.

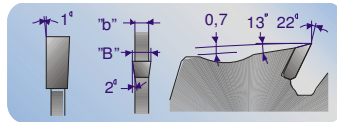

D	B	b	z	£
200	2.0	1.4	16+2	124.92
200	2.5	1.8	16+2	124.92
225	2.0	1.4	18+2	124.92
225	2.5	1.8	18+2	124.92
250	2.5	1.8	20+2	125.84
250	2.8	2.0	20+2	125.84
280	2.8	2.0	22+2	132.42
300	2.8	2.0	24+2	140.25

22AA39R

With large gullets and wiper slots. Pin holes for the Raimann machine

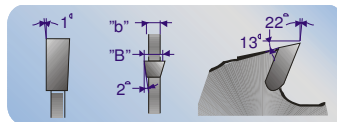

D	B	b	z	£
300	3.2	2.2	24+2	154.55
350	3.5	2.5	24+4	209.41
360	3.5	2.5	24+4	209.41

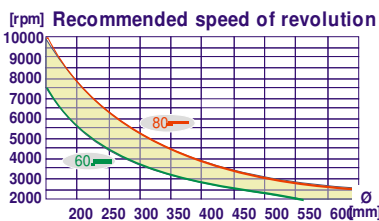

Wiper slot blades are Multi-rip blades. The wiper slots reduce the risk of getting stuck and also of the saw body becoming burnt. The guard tooth throws out loose cuttings and keeps the cutting groove clean. The blades can be used for sawing both green and dry wood

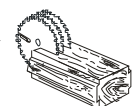



Rip Saw Blades with Wiper Slots-Thin Kerf

22AA46RT2

With large gullets and wiper slots. Diameter 180 to 400mm

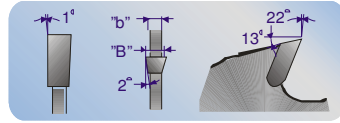

D	B	b	z	f
180	2.4	1.6	12+2	124.92
200	2.4	1.6	14+2	124.92
225	2.8	1.9	16+2	124.92
250	2.8	1.9	16+2	124.92
280	2.8	1.9	18+2	132.42
300	2.8	1.9	20+2	140.25
315	2.8	1.9	20+2	143.59
350	3.2	2.2	24+2	156.50
400	3.2	2.2	28+2	176.32

Wiper Slots

The Wiper slot length depends on the centre bore size and flange diameter

D	c-bore	WS Length
160		25
180		25
200		25
225	≤ 70	35
225	> 70	25
250	≤ 70	50
250	> 70	35
280		50
300	≤ 70	60
300	> 70	50
315	≤ 80	70
315	> 80	60
350	≤ 100	70
350	> 100	60
400		70

Always state saw height, feed speed, revolution and size of the flanges when ordering a saw blade

22AA46SRT3

With guard teeth and wiper slots.

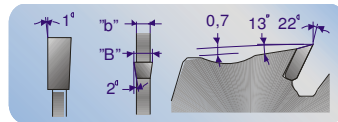

D	B	b	z	f
180	2.0	1.3	12+2	124.92
200	2.0	1.3	14+2	124.92
225	2.4	1.6	16+2	124.92
250	2.4	1.6	16+2	124.92
280	2.4	1.6	18+2	132.42
300	2.4	1.6	20+2	140.25
315	2.4	1.6	20+2	143.59
350	2.8	1.9	24+2	156.50
400	2.8	1.9	28+2	176.32

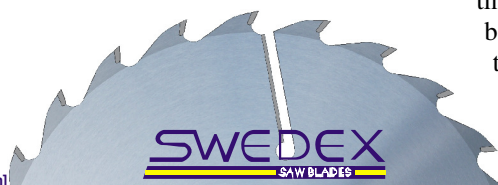
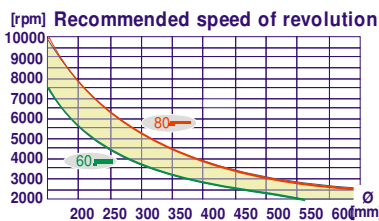

Wiper slot blades are Multi-rip blades. The wiper slots reduce the risk of getting stuck and also of the saw body becoming burnt. The guard tooth throws out loose cuttings and keeps the cutting groove clean. The blades can be used for sawing both green and dry wood

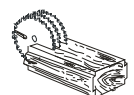



Ripping Blades

22BA39

Ripping saw blade for solid wood

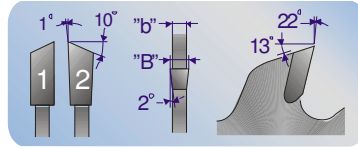

D	B	b	z	£
150/160	2.8	1.9	12	58.19
180	2.8	1.9	14	58.90
200	2.8	1.9	16	61.29
225	3.2	2.2	18	68.68
250	3.2	2.2	20	70.98
260/280	3.2	2.2	22	81.24
300	3.2	2.2	24	84.74
315	3.2	2.2	24	89.67
350	3.5	2.5	28	105.33
400	3.5	2.5	32	117.31
430	4.0	3.0	34	171.63
450	4.0	2.8	36	159.72
500	4.0	2.8	40	189.58
560	4.4	3.0	44	244.98
610	4.4	3.0	48	265.87
650	4.4	3.0	52	401.71
700	4.4	3.0	56	410.71
760	4.4	3.0	60	709.33

22AA39B2

A more stable blade than the 22BA39. Can also be used as an outer blade.

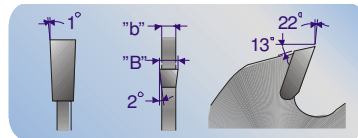

D	B	b	z	£
180	3.2	2.2	14	81.89
200	3.2	2.2	16	90.80
225	3.5	2.5	18	103.52
250	3.5	2.5	20	113.57
280	3.5	2.5	22	121.41
300	3.5	2.5	24	121.41
350	4.0	2.8	28	140.59
400	4.0	2.8	32	158.78

22AA39T2

Similar design to 22AA39B2, but with a much thinner kerf.

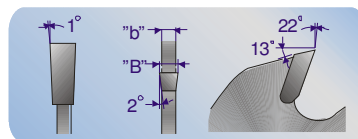

D	B	b	z	£
160	2.4	1.6	12	60.77
180	2.4	1.6	14	62.49
200	2.4	1.6	16	64.63
225	2.8	1.9	18	75.02
250	2.8	1.9	20	76.22
280	2.8	1.9	22	85.83
300	2.8	1.9	24	89.02
350	3.2	2.2	28	111.01
400	3.2	2.2	32	124.15
450	3.5	2.5	36	174.14

10BA30

A ripping blade suitable for cross-cutting

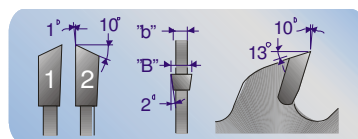

D	B	b	z	£
400	3.5	2.5	40	135.05
450	4.0	2.8	44	171.92
500	4.0	2.8	50	212.04
550	4.4	3.0	56	269.55
610	4.4	3.0	60	283.71

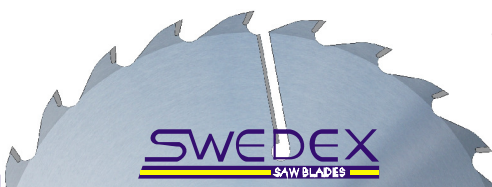
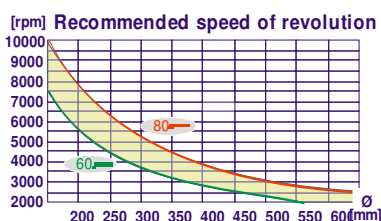

Swedex offer a wide range of sawblades for ripping both hard & soft wood. Alternate bevelled tooth design is recommended when ripping hard wood.

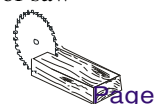



Ripping Blades

22BA30

For ripping of hard & soft wood. Tooth shape BA is recommended for hard wood. Can also be used for multi-rip sawing of dry, planed wood.

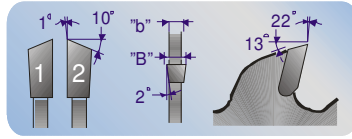

22BA30T3

Rip-saw blade with extra small cutting width

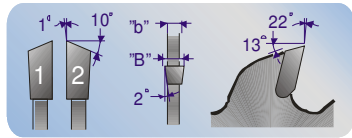

22BA26

Rip-saw blade with a closer tooth pitch. Suitable for both hard and soft wood.

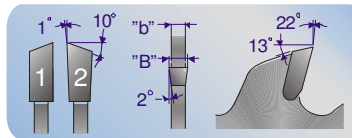

D	B	b	z	f
180	2.8	1.9	18	61.98
200	2.8	1.9	20	63.97
225	3.2	2.2	22	76.86
240	3.2	2.2	24(AA)	76.86
250	3.2	2.2	24	76.86
280	3.2	2.2	28	84.38
300	3.2	2.2	30	88.15
315	3.2	2.2	30	92.83
330	3.5	2.5	32	112.34
350	3.5	2.5	36	112.34
400	3.5	2.5	40	135.05
450	4.0	2.8	44	171.92
500	4.0	2.8	50	212.04
560	4.4	3.0	56	269.55
610	4.4	3.0	60	283.71
650	4.4	3.0	64	495.05
700	4.4	3.0	72	509.34

D	B	b	z	f
160	2.0	1.3	16	67.55
180	2.0	1.3	18	69.11
200	2.0	1.3	20	70.72
225	2.4	1.6	22	83.65
250	2.4	1.6	24	86.69
280	2.4	1.6	28	102.21
300	2.4	1.6	30	102.21
350	2.8	1.9	36	123.00
400	2.8	1.9	40	148.37

D	B	b	z	f
160	2.8	1.9	18	67.10
180	2.8	1.9	20	67.10
190/200	2.8	1.9	24	68.44
225	3.2	2.2	28	79.95
250	3.2	2.2	30	79.95
270	3.2	2.2	30	85.58
300	3.2	2.2	36	91.96
350	3.5	2.5	42	116.74
400	3.5	2.5	48	140.25
450	4.0	2.8	56	172.62
500	4.0	2.8	60	221.71
560	4.4	3.0	64	280.01
610	4.4	3.0	72	325.55
650	4.4	3.0	78	519.72
700	4.4	3.0	84	529.99

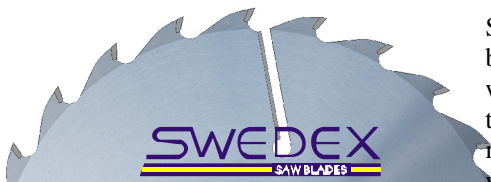
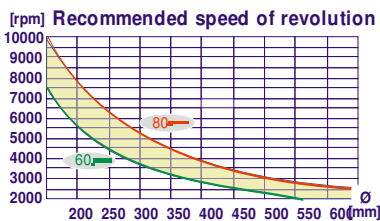

Swedex offer a wide range of saw-blades for ripping both hard & soft wood. Alternate bevelled tooth design is recommended when ripping hard wood.

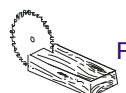



Universal Blades

22BA19

Universal saw blade for most common saw operations but primarily suitable for ripping wood in thinner sections, Suitable for both hard and soft wood.

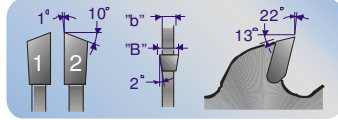

D	B	b	z	£
150/160	2.8	1.9	24	69.89
180	2.8	1.9	28	77.79
200	2.8	1.9	32	80.68
225	3.2	2.2	36	89.67
250	3.2	2.2	40	89.67
280	3.2	2.2	44	107.76
300	3.2	2.2	48	110.49
315	3.2	2.2	48	115.36
335	3.5	2.5	48	129.73
350	3.5	2.5	56	132.08
400	3.5	2.5	64	156.83
450	4.0	2.8	72	204.07
500	4.0	2.8	80	238.60
550	4.4	3.0	90	343.64
600	4.4	3.0	96	370.15

22BA19T2

Universal saw blade with narrow cutting width. Suitable for both hard and soft wood.

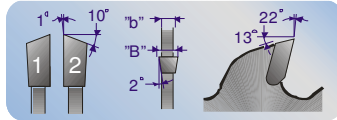

D	B	b	z	£
150/160	2.4	1.6	24	71.24
180	2.4	1.6	28	79.29
200	2.4	1.6	32	81.44
225	2.8	1.9	36	90.52
250	2.8	1.9	40	90.52
300	2.8	1.9	48	112.64
315	2.8	1.9	48	117.60
350	3.2	2.2	56	133.34
400	3.2	2.2	64	158.36
450	3.5	2.5	72	205.25
500	3.5	2.5	80	240.90
550	3.5	2.5	90	346.99
600	3.5	2.5	96	373.76

22BA19T3

Extra narrow cutting width with low cutting resistance. Suitable for frame ripping in thin sections. Is also used for edge trimming.

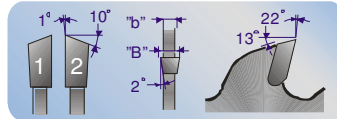

D	B	b	z	£
125	2.0	1.3	20	72.26
150/160	2.0	1.3	24	72.26
180	2.0	1.3	28	76.67
200	2.0	1.3	32	86.69
225	2.4	1.6	36	102.21
250	2.4	1.6	40	102.21
300	2.4	1.6	48	115.36
315	2.4	1.6	48	119.83
350	2.8	1.9	56	146.84
400	2.8	1.9	64	177.39

22AA19T4

Extremely small kerf. Double sided hub. NOTE: Limited cutting depth.

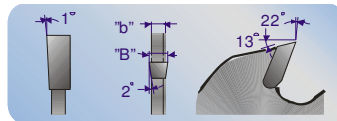

D	B	b	Max Cut. depth	z	£
160	1.5	0.9/1.9	22	24	115.36
180	1.5	0.9/1.9	26	28	128.29
200	1.5	0.9/1.9	30	32	140.74
250	1.5	0.9/1.9	37	40	175.28
300	1.5	0.9/1.9	44	48	201.36
350	1.8	1.2/2.5	52	56	251.29
400	1.8	1.2/2.5	60	64	278.19

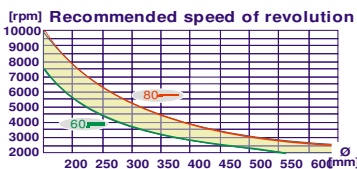

For ripping of hard & soft wood. Can also be used for cross-cutting

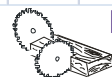



Cross-cut, Trim & Panel sizing

6BA10

Close tooth trimming saw blade for laminated materials and plastics. For use when a good surface finish is required. Equipped with Swedex Long-life teeth for maximum wear resistance and long life. Alternate bevel tooth style.

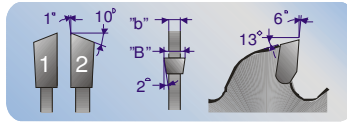

6EA10

Close tooth trimming saw blade for laminated materials and plastics. For use when a good surface finish is required. Equipped with Swedex Long-life teeth for maximum wear resistance and long life. EA tooth style.

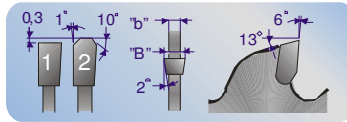

6BA10T2

As 6BA10 but with narrow cutting width.

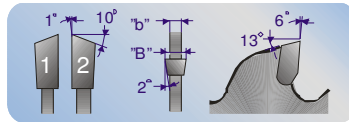

6BA10T3

Extra narrow cutting width. Cross cut blade for thin plastic profiles, printed circuits, plexiglass etc.

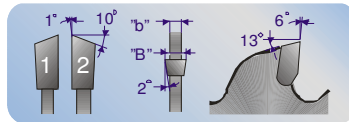

6EA10T3

Extra narrow cutting width. Cross cut blade for thin plastic profiles, printed circuits, plexiglass etc. EA tooth style.

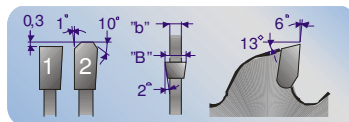

6BA10B2

Scoring Blade for tenoners. Made with long life carbide

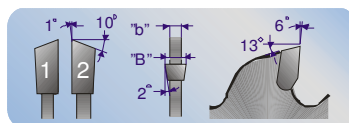

D	B	b	z	£
150/160	2.8	1.9	48	83.76
180	2.8	1.9	56	93.56
190/200	2.8	1.9	64	101.86
210	2.8	1.9	64	110.70
220	3.2	2.2	72	116.39
225	3.2	2.2	72	116.39
250	3.2	2.2	80	117.33
255	3.2	2.2	80	120.68
270	3.2	2.2	84	132.80
300	3.2	2.2	96	134.28
330	3.5	2.5	104	159.30
350	3.5	2.5	112	159.30
400	3.5	2.5	120	204.08
450	4.0	2.8	144	259.91
500	4.0	2.8	160	309.77
550	4.4	3.0	168	389.61
600	4.4	3.0	176	451.50

D	B	b	z	£
150/160	2.4	1.6	48	86.69
180	2.4	1.6	56	95.19
200	2.4	1.6	64	108.46
250	2.8	1.9	80	123.69
300	2.8	1.9	96	148.61
350	3.2	2.2	112	182.43
400	3.2	2.2	120	217.47

D	B	b	z	£
125	2.0	1.3	40	96.09
150/160	2.0	1.3	48	96.09
180	2.0	1.3	56	105.61
200	2.0	1.3	64	118.51
225/250	2.4	1.6	80	135.08
300	2.4	1.6	96	156.58
350	2.8	1.9	112	196.30
400	2.8	1.9	120	224.26

D	B	b	z	£
125	3.2	2.2	40	100.37
150-160	3.2	2.2	48	100.37
180	3.2	2.2	56	111.89
200	3.2	2.2	64	122.49
300	3.5	2.5	96	154.40

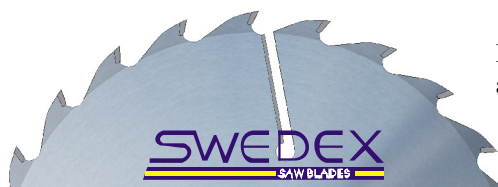

Blades for cross-cutting of wood and for trimming and panel sizing of chipboards, laminated or non-laminated boards.

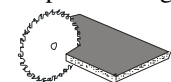



Cross-cut, Trim & Panel sizing

6AA10T4

Extremely narrow cutting width. Trimming saw blade for thin plastics and printed circuits.

NOTE: Limited cutting depth.

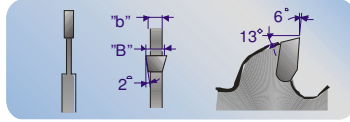

D	B	b	Max.Cut.Depth	z	£
150	1.5	0.9/1.9	20	48	132.74
160	1.5	0.9/1.9	22	48	132.74
180	1.5	0.9/1.9	26	56	147.44
200	1.5	0.9/1.9	30	64	160.48
250	1.5	0.9/1.9	37	80	201.00
300	1.5	0.9/2.2	44	96	230.38
350	1.8	1.2/2.5	52	112	288.52
400	1.8	1.2/2.5	60	120	318.95

Fast cut 6BA11

Close toothed saw blade for “Opti-cut” saws. Extra stable body. Differentiated tooth pitch together with copper rivets.

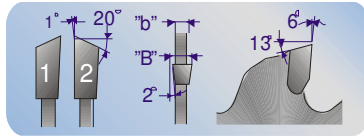

D	B	b	z	£
400	4.8	3.5	96	311.59
450	4.8	3.5	128	338.08
500	4.8	3.5	96	346.00
500	4.8	3.5	144	355.85
550	4.8	3.5	96	441.49
550	4.8	3.5	144	569.24
600	5.4	4.0	96	533.79
600	5.4	4.0	144	580.49
600	5.4	4.0	172	606.12
650	5.4	4.0	96	712.36

6BA8T3

Narrow cutting width and extremely close-toothed. Intended for cutting very thin materials. BA toothstyle

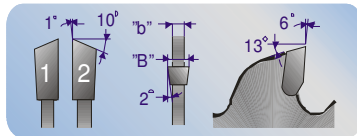

D	B	b	z	£
150/160	2.0	1.3	60	116.78
180	2.0	1.3	70	146.84
200	2.0	1.3	80	158.94
225	2.4	1.6	90	188.30
250	2.4	1.6	100	188.31
300	2.4	1.6	116	212.16
350	2.8	1.9	144	272.89
400	2.8	1.9	160	302.01

6EA8T3

Narrow cutting width and extremely close-toothed. Intended for cutting very thin materials. EA toothstyle

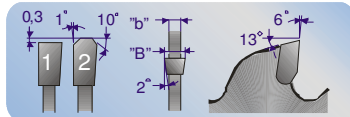

D	B	b	z	£
150/160	2.4	1.6	30	73.56
180	2.4	1.6	36	75.99
200	2.4	1.6	40	85.85
250	2.8	1.9	50	99.01
300	2.8	1.9	60	117.87
350	3.2	2.2	70	143.24
400	3.2	2.2	80	170.70

15BA16T2

Universal saw blade, fine toothed with narrow cutting width. Suitable for ripping and cross-cutting of both hard and soft wood or thin board.

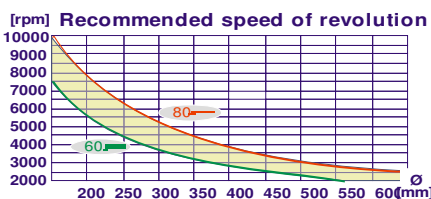
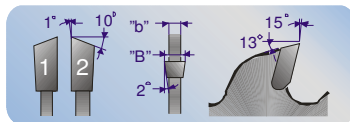

Blades for cross-cutting of wood and for trimming and panel sizing of chipboards, laminated or non-laminated boards.

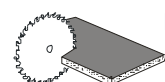



Cross-cut, Trim & Panel sizing

8BA13

Close toothed trimming blade for veneered and laminated material. For use when a good surface finish is required.

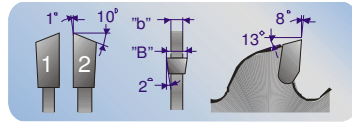

8EA13

Close toothed trimming blade for veneered and laminated material. For use when a good surface finish is required.

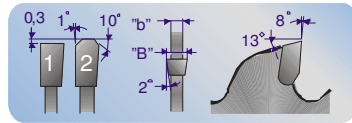

8BA13B2

Scoring blade for tenoners. Made with long life carbide

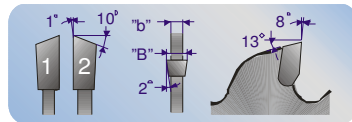

10BA16

Trimming and sizing saw blade. Standard blade for the carpentry and furniture industry. Used for non-laminated and single-side laminated board. BA style

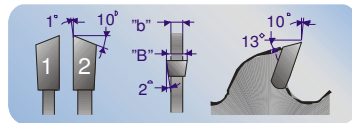

10EA16

Trimming and sizing saw blade. Standard blade for the carpentry and furniture industry. Used for non-laminated and single-side laminated board. EA style

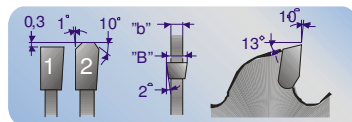

D	B	b	z	£
125	2.8	1.9	30	76.05
150/160	2.8	1.9	36	76.05
180	2.8	1.9	42	83.54
200	2.8	1.9	48	89.89
210	2.8	1.9	48	94.93
220	3.2	2.2	56	102.79
225	3.2	2.2	56	102.79
240	3.2	2.2	60	103.71
250	3.2	2.2	60	103.71
280	3.2	2.2	72	120.28
300	3.2	2.2	72	120.28
315	3.2	2.2	80	146.73
330	3.5	2.5	80	146.73
350	3.5	2.5	84	146.73
370	3.5	2.5	90	177.92
400	3.5	2.5	96	177.92
450	4.0	2.8	108	242.67
500	4.0	2.8	120	268.09
550	4.4	3.0	132	358.16
600	4.4	3.0	144	395.86

D	B	b	z	£
125	3.2	2.2	30	89.77
150	3.2	2.2	36	89.77
180	3.2	2.2	42	99.68
200	3.2	2.2	48	107.39

D	B	b	z	£
150/160	2.8	1.9	30	72.92
180	2.8	1.9	36	77.55
200	2.8	1.9	40	88.52
250	3.2	2.2	50	99.45
300*	3.2	2.2	60	118.74
315	3.2	2.2	60	141.41
350*	3.5	2.5	70	144.14
400	3.5	2.5	80	166.52
450	4.0	2.8	90	209.17
500	4.0	2.8	100	248.11
550	4.4	3.0	108	342.22
600*	4.4	3.0	120	374.75



Blades for cross-cutting of wood and for trimming and panel sizing of chipboards, laminated or non-laminated boards.

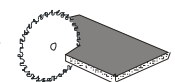



Cross-cut, Trim & Panel sizing

10BA19

Cross-cut, trimming and panel saw blade for hard-board, plasterboard and chipboard etc.
Also manufactured with a 5 degree negative hook an-

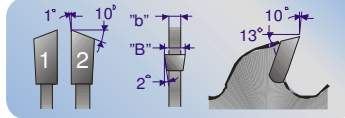

D	B	b	z	£
180	2.8	1.9	28	72.30
200	2.8	1.9	32	77.55
225	3.2	2.2	36	80.78
250	3.2	2.2	40	85.29
255	3.2	2.2	40	90.21
270	3.2	2.2	42	101.86
300	3.2	2.2	48	105.42
315	3.2	2.2	48	115.13
330	3.5	2.5	52	127.58
350	3.5	2.5	56	127.58
380	3.5	2.5	60	153.07
400	3.5	2.5	64	153.07
450	4.0	2.8	72	191.95
500	4.0	2.8	80	222.96
560	4.4	3.0	90	287.26
610	4.4	3.0	96	340.06
650	4.4	3.0	108	546.70

BLADE FACT

Frequently asked questions

What can I do to obtain a better cutting surface finish?

- Choose a saw blade with more teeth.
- Use a higher peripheral speed.
- Select a saw blade with different tooth shape.
- Check flanges and distances.
- Condition of the spindle bearings.

The blade is very noisy, especially when idling, why?

- The blade goes into oscillation (self-vibration).
- Change number of teeth and diameter.
- Adjust the speed of revolution if possible.
- You can also choose a sound absorbing saw blade.
- A coating of sound absorbing material on the inside of the safety cover.

How to avoid chip outs on the bottom side of the material?

- Use a saw blade with more teeth.
- The saw blade is positioned too high above the material.
- Some special grindings and angles may help.

Why does the saw blade wobble when warm?

- During cutting the saw blade becomes warm, especially in the periphery, which causes the blade to expand and stretch. We can add slots for improved blade properties to meet a specific customer's needs.

How to avoid the blade chopping when cutting aluminium?

- When using manual feed, a negative hook angle results

BLADE FACT

Carbide tips are made out of a metallic material consisting of hard grains of carbide held together by a binding agent. The most common carbide is tungsten carbide and the most common binding agent is cobalt. To improve toughness, the binding agent is sometimes alloyed with other metallic elements.

Carbides are chemical alloys of one or more metals and consist of very small grains. The grain size varies from 1 to around 7 microns (1 micron = 0.001 mm).

The hardness of the carbide tip is adjusted by the size of grain. Harder carbide gives a longer wear resistance but will be more brittle. Larger

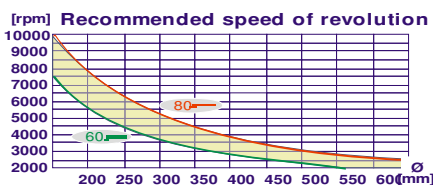
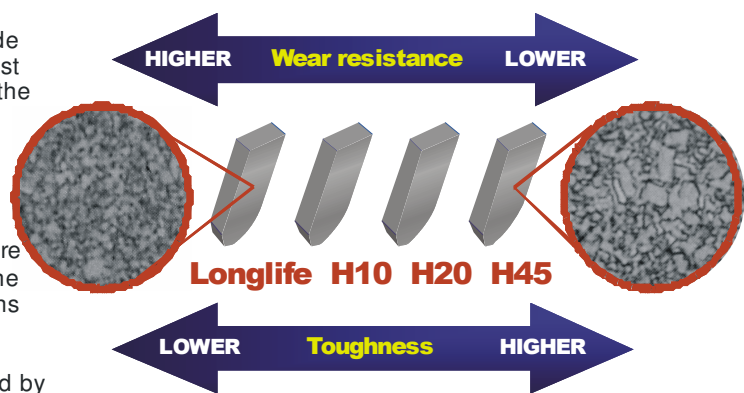

Blades for cross-cutting of wood and for trimming and panel sizing of chipboards, laminated or non-laminated boards.

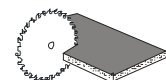



Negative blades for wood & plastic

N5BA8/N5BA10

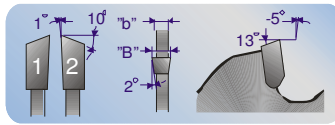

D	B	b	z	£
216	2.8	1.9	80	151.07

N2EA8/N5EA10

Close toothed blade for laminated material and plastics. For use when a good surface finish is required.

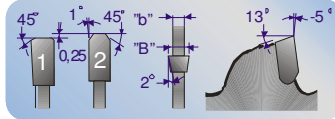

D	B	b	z	£
216	2.8	1.9	64	105.23
250	3.2	2.2	80	117.33
260	3.2	2.2	80	122.13
300	3.2	2.2	96	140.71
305(T2)	2.8	1.9	96	147.52
305	3.2	2.2	96	147.52
350	3.5	2.5	112	172.86

N5BA13

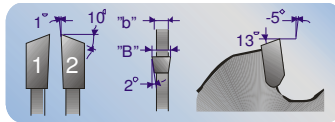

D	B	b	z	£
216	2.8	1.9	48	93.01
250	3.2	2.2	60	103.21
260	2.8	1.8	60	116.05
260	3.2	2.2	60	116.05
260	3.2	2.2	80	122.13
300	3.2	2.2	72	125.26
350	3.5	2.5	84	155.11

N5EA13

Close toothed blade for veneered & laminated material. For use when a good surface finish is required.

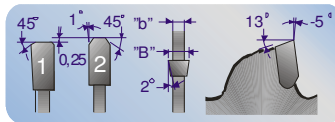

N5BA16/(EA*)

Trimming and sizing blade for the carpentry and furniture industry. Used for non-laminated and single sided board.

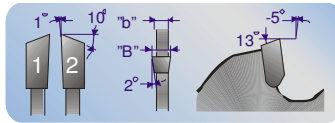

D	B	b	z	£
305*	3.2	2.2	60	116.55
400	3.5	2.5	80	166.92
420	3.5	2.5	84	211.92
450	4.0	2.8	90	218.14

N5BA19

Cross cut blade for hardboard and chipboard etc.

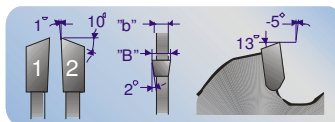

D	B	b	z	£
250	3.2	2.2	40	88.52
300	3.2	2.2	48	112.93
350	3.5	2.5	56	136.67
400	3.5	2.5	64	160.65
450	4.0	2.8	72	206.06
500	4.0	2.8	80	244.97

N5BA26/N5BA39

Rip-saw blades. Suitable for both hard and soft wood.

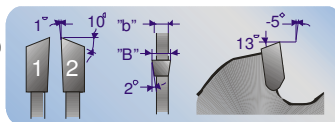

D	B	b	z	£
216*	2.8	1.9	24	70.79
250	2.8	1.8	30	79.97
260	2.8	1.9	30	84.42
305	3.2	2.2	24	96.18
520	4.4	3.0	60	275.91
550	4.4	3.0	56	269.66
565	4.4	3.0	56	289.11

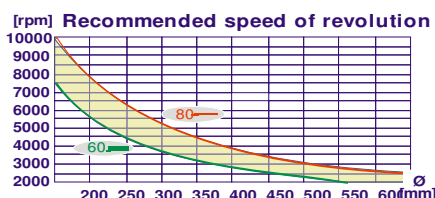

Blades with a negative hook angle for chop saws, overhead crosscut and radial arm saws. Used where the blade is above the work piece.

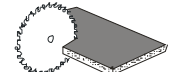

Edge banding , Nail resistant & Splitter/planers

22BA17

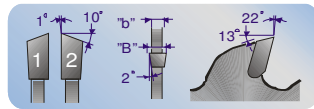

D	B	b	z	£
100	3.2	2.2	20	101.78
110	3.6	2.5	20	99.82

10BA15

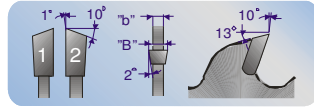

115	2.6	1.6	24	82.05
120	3.2	2.5	24	98.82
140	3.2	2.2	36	125.51
160	3.2	2.2	24	102.50

10AA19

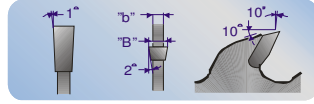

15BA12

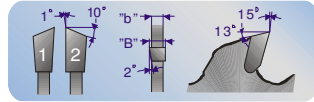

15BA19

Blades for edge-banding. Non-handed

8CA/DA14

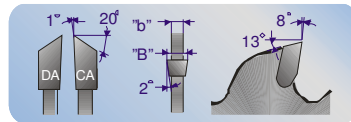

8CA/DA16

D	B	b	z	£
92	3.2	2.2	20	96.79
100	3.2	2.2	20	101.78

Blades for edge-banding. Handed. CA=right, DA=left

N2EE46

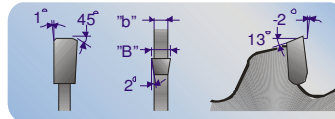

Special saw blades for use with low quality timber with metal inclusions etc.
Suitable for wooden pallets.

D	B	b	z	£
300	3.4	2.2	20	85.63
350	3.8	2.5	24	108.00
400	3.8	2.5	28	120.51
450	4.2	2.8	32	166.47
500	4.2	2.8	40	192.61

22/17AA15sp

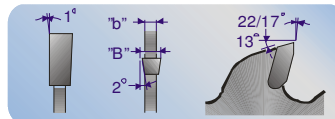

A saw blade developed to split the material and leave a planed finish. For best results use with a hydrosleeve.
Max. cutting speed 100 m/min

D	B	b	z	£
180	3.5	2.5	38	162.06
200	3.5	2.5	42	181.10
225	3.5	2.5	48	198.58
250	3.5	2.5	54	255.32

25AA25BO

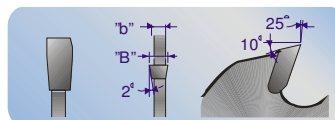

The teeth have facet ground sides which result in a very smooth cutting surface. Oxide coated with a maximum cutting depth of 50mm.

D	B	b	z	c	£
225	3.4	2.4	28	60	199.70
250	3.4	2.4	36	60	209.71

Feed Speed up to 150 m/min.

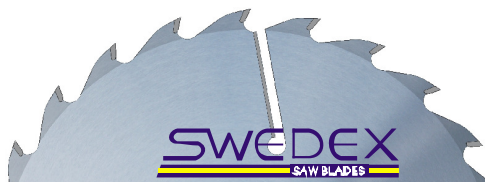

Special blades for wood & paper

5EA10T2 10EA19T2

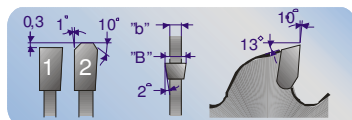

D	B	b	z	£
120	1.8	1.2	24	92.44
120	1.8	1.2	36	96.85

For the Varga engraving machine

6BA11

For optimiser machines

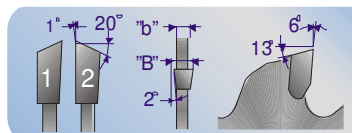

D	B	b	z	£
400	4.8	3.5	96	311.59
450	4.8	3.5	128	338.07
500	4.8	3.5	96	346.00
500	4.8	3.5	144	355.85
550	4.8	3.5	96	441.49
550	4.8	3.5	144	569.24
600	5.4	4.0	96	533.79
600	5.4	4.0	144	580.49
600	5.4	4.0	172	606.12
650	5.4	4.0	96	712.36

6BA11

For optimiser machines

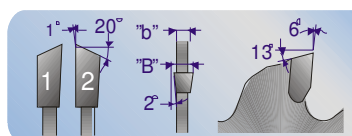

D	B	b	z	£
600	5.4	4.0	144	580.49
600	5.4	4.0	172	606.12
650	5.4	4.0	96	712.36

10BA10

Janser m/c-c/sunk bore

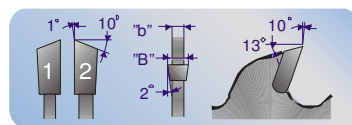

D	B	b	z	£
120	2.6	2.0	48	103.08

15BA18

Truss saw blade for the
Randek truss machine

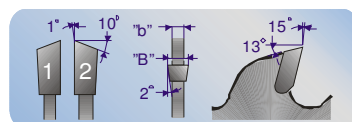

D	B	b	z	£
700	4.5	3.5	120	642.62

22AA39R

For the Raimann machine

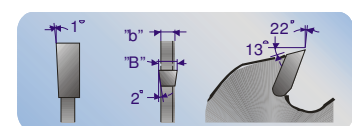

D	B	b	z	£
300	3.2	2.2	24+2	154.55
350	3.5	2.5	24+4	209.41
360	3.5	2.5	24+4	209.41

30AA34

For the Lucas portable saw

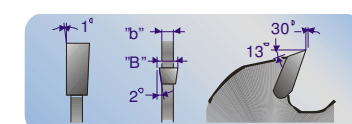

D	B	b	z	£
424	5.0	2.85	5	218.99
546	5.7	3.2	5	296.19
585	6.1	3.55	5	360.54

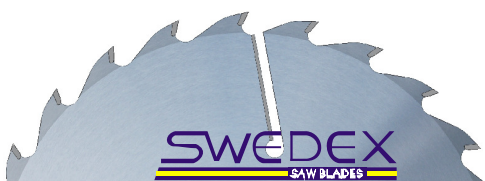

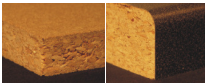

Panel sizing blades for vertical saws

6EA10

Panel sizing saw blade for vertical saws. Long life teeth and small tooth pitch. For panel sizing of laminated or non-laminated boards.

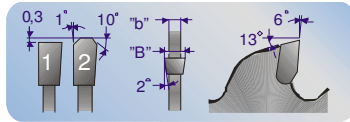

D	B	b	z	£
220	3.2	2.2	72	116.39
250	3.2	2.2	80	117.33
300	3.2	2.2	96	134.28
350	3.5	2.5	112	159.30

10EAXH16

Panel sizing saw blade for vertical saws. For panel sizing of laminated or varnished boards when a good finish is required. Hollow ground front

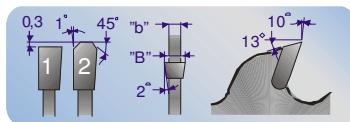

D	B	b	z	£
220	3.2	2.2	42	105.50
250	3.2	2.2	48	117.85
303	3.2	2.2	60	141.26
350	3.2	2.2	70	183.28
400	3.5	2.5	80	231.57
450	3.9	2.8	90	282.87
500	3.9	2.8	100	297.69

BLADE FACT

A carbide tipped blade is a precision tool that requires careful maintenance to ensure a long service life and good performance throughout its life.

The blade must be re-sharpened at the right time, i.e. when the cut surface becomes unacceptable. This usually happens when the tip edge radius exceeds 0.1 mm or when the cutting edge becomes chipped. Normally a carbide tipped blade can be re-sharpened 20-25 times depending on the size of the carbide tips.

Clean the blade regularly to remove the coating of chips and resin that sticks to cutting edges, gullets and saw body. The coating increases the friction as well as the temperature and causes the blade to run hot and twist. The increased wear may in the worst case cause the blade to crack. We recommend the use of a good cleaning agent.

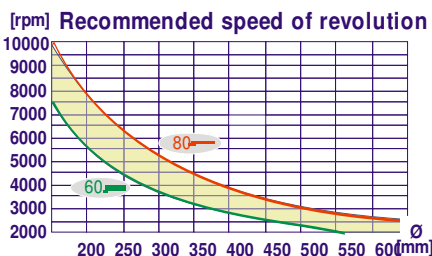
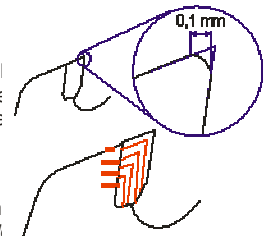

Blades for vertical panel sizing, e.g. Holz-Her, Striebig etc.

For laminated or varnished boards.

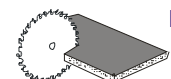

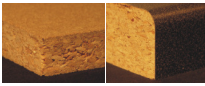

Panel sizing saw blades(Wide kerf)

Panel sizing saw blades for use with a scribing unit. The blades have a laser dampened saw body and are equipped with long life carbide teeth, which results in a longer time between sharpening.

10EA13UB2

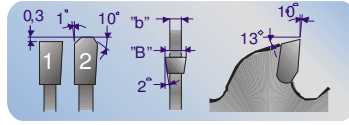

D	B	b	z	£
300	4.4	3.2	72	168.45
350	4.4	3.2	84	193.86

10EA16UB2

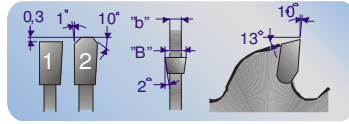

D	B	b	z	£
300	4.4	3.2	60	143.01
320/330	4.4	3.2	72	168.45
350	4.4	3.2	72	174.53
355	4.4	3.2	70	174.53
370	4.4	3.2	72	197.18
380	4.4	3.2	72	197.18
380	4.8	3.5	72	222.27
400	4.4	3.2	72	209.79
470	4.4	3.2	96	299.25

15EA19UB2

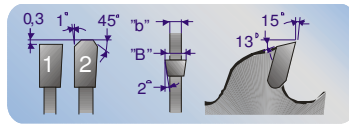

D	B	b	z	£
350	4.4	3.2	56	164.95
400	4.4	3.2	64	191.58
420	4.8	3.5	72	267.68
430	4.4	3.2	72	236.53
430	4.8	3.5	72	267.88
450	4.4	3.2	72	236.53
450	4.8	3.5	72	286.47
500	4.8	3.5	72	311.70

15EA21UB2

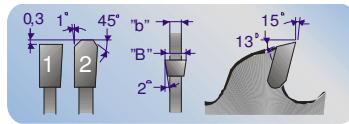

D	B	b	z	£
480	4.4	3.2	72	275.54
480	4.8	3.5	72	287.41

15EA25UB2

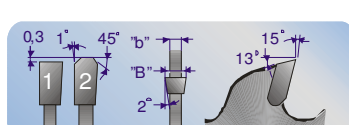

D	B	b	z	£
480	4.8	3.5	60	268.41
400	4.4	3.2	48	169.17
450	4.4	3.2	56	203.96

15EA26UB2

N6EA13sp

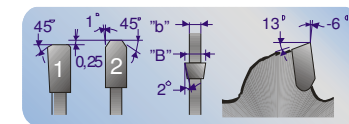

D	B	b	z	£
350	3.2	2.5	84	197.30
400	3.2	2.5	96	241.32
450	4.0	3.2	108	293.01
500	4	3.2	120	366.03

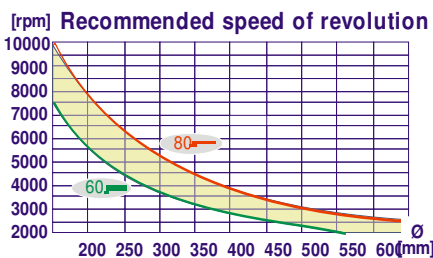

Blades for vertical panel sizing,
e.g. Holz-Her, Striebig etc.
For laminated or varnished
boards.

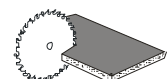

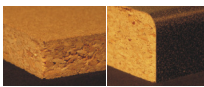

Scoring blades

10RA19

Scoring saw blades with straight teeth and conical sides (RA). Manufactured with Long-life carbide tips

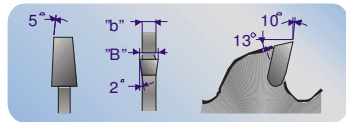

D	B	b	z	£
80	3.0-4.0	2.2	10	58.64
90	3.2-4.4	2.2	20	63.72
100	3.2-4.4	2.2	20	71.69
105	3.2-4.4	2.2	20	71.69
120	3.2-4.4	2.2	20	74.18
120	3.5-4.5	3.2	20	91.59
120	4.4-5.4	3.2	20	93.15
125	3.2-4.4	2.2	20	76.35
125	3.5-4.5	2.5	20	91.59
125	4.4-5.4	3.2	20	93.15
140	3.1-4.2	2.2	32	99.62
150	3.2-4.2	2.2	24	103.41
150	4.4-5.4	3.2	24	103.71
160	4.4-5.4	3.2	24	105.14
160	4.8-5.8	3.5	24	113.96
175	4.4-5.4	3.2	28	111.82
175	4.8-5.8	3.5	28	114.14
180	3.5-4.5	2.5	28	117.16
180	4.4-5.4	3.2	28	118.35
180	4.8-5.8	3.5	28	121.48
200	3.2-4.4	2.2	32	130.20
200	4.4-5.4	3.2	32	132.37
200	4.8-5.8	3.5	32	136.97
215	4.4-5.4	3.2	42	135.42
280	4.8-5.8	3.5	72	238.80
300	4.4-5.4	3.2	48	180.12
300	4.8-5.8	3.5	48	201.95

10RA/BA

Scoring saw blade with alternately bevelled teeth with conical sides (RABA) Manufactured with Long-life carbide tips.

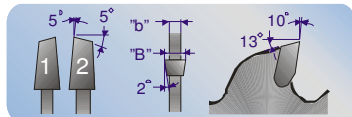

D	B	b	z	£
280	4.8-5.8	3.5	72	238.80
300	4.4-5.4	3.2	48	180.12
300	4.8-5.8	3.5	48	201.95

SPLIT SCORERS

Adjustable to suit the kerf of the main saw blade. Straight teeth (AA). Shims are included.

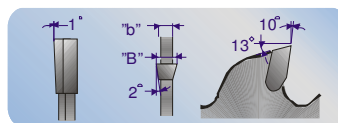

D	B	z	£
80	2.8-3.6	2x10	100.88
100	2.8-3.6	2x12	100.88
105	2.8-3.6	2x12	110.96
120	2.8-3.6	2x12	110.96
125	2.8-3.6	2x12	110.96
140	2.8-3.6	2x14	116.92

SPLIT SCORER for the Altendorf Rapido machine. Blade has 50mm bore and 4 Counter-sunk pin holes

D	B	z	£
120	2.8-3.6	2x12	124.57

[rpm] Recommended speed of revolution

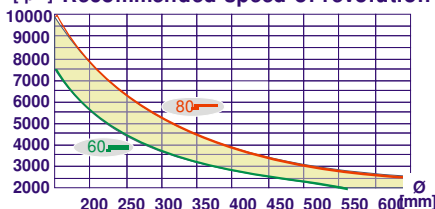

Scoring saw blades equipped with long-life carbide tips. Used for scoring of laminated and non-coated boards.

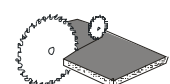

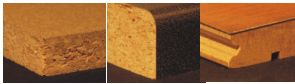

Tenoner, Scoring blades and Hoggers

6BA10B2

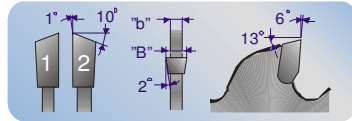

Scoring blade for tenoners. BA toothform with long-life carbide tips

D	B	b	z	£
125	3.2	2.2	40	100.37
150	3.2	2.2	48	100.37
160	3.2	2.2	48	100.37
180	3.2	2.2	56	111.89
200	3.2	2.2	64	122.49
300	3.5	2.5	96	154.40

8BA13B2

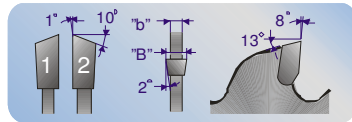

Scoring saw blade for tenoners. BA toothstyle with Long-life carbide

D	B	b	z	£
125	3.2	2.2	30	89.77
150	3.2	2.2	36	89.77
180	3.2	2.2	42	99.68
200	3.2	2.2	48	107.39

22AA39B2

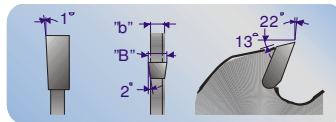

Scoring blade for tenoners. BA toothform

D	B	b	z	£
180	3.2	2.2	14	81.89
200	3.2	2.2	16	90.80
225	3.5	2.5	18	103.52

LEUCO

Scoring blade for the Leuco system. Manufactured with long-life carbide. With BA toothstyle but can also be produced left or right handed

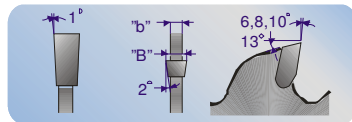

	D	B	b	C	Z	PH	£
6AA10	180	3.2	2.2	50	56	3/22/80	123.56
8AA13	180	3.2	2.2	50	42	3/22/80	110.50
10AA16	180	3.2	2.2	50	36	3/22/80	98.34

HOMAG

Scoring blade for Homag, Brandt, IMA. Manufactured with long-life carbide. Right (CA) or left (DA). Can also be produced BA toothstyle.

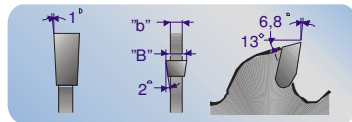

	D	B	b	C	Z	Csk	PH	L/R	£
6AA10	180	3.2	2.2	65	56	6/7/60/10.5			123.56
8AA13	180	3.2	2.2	65	42	6/7/60/10.5			110.50

LEUCO HOGGER

For panel sizing of laminated or non-laminated boards. Produced with long-life carbide tips. Left or right handed. Can also be manufactured with BA

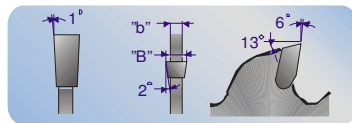

	D	B	b	C	Z	Csk	PH	L/R	£
6AA10	200	4.0	2.8	80	64-4	4/6.5/140			141.50
6AA11	220	4.0	2.8	80	64-4	6/6/154			146.87
6AA10	250	4.0	2.8	80	78-6	6/6.5/200			155.42
6AA10	250	4.0	2.8	100	78-6	6/6.5/200			155.42

10CA/DA16

Trim saw blade for edge trimming. Long life carbide. Right (CA) or left (DA)

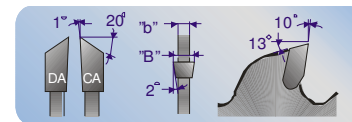

	D	B	b	C	Z	Csk	PH	L/R	£
CA/DA	100	3.2	2.2	32	20	2/4/52			101.78

[rpm] Recommended speed of revolution

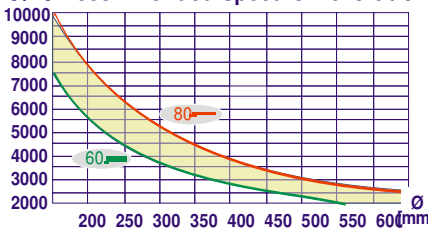

Scoring saw blades equipped with long-life carbide tips. Used for scoring of laminated and non-coated boards.

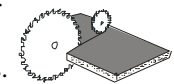

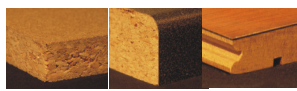

Groove cutting saw blades

20AA26

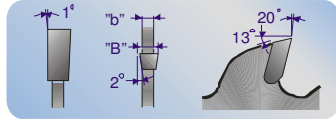

Groove cutting saw blades for wood, chipboards and non-ferrous metals with moderate feed speeds.

D	B	b	z	£
100	1.5	1.0	12	104.17
100	2.0	1.3	12	95.31
100	2.5	1.5	12	93.01
100	3.0	2.0	12	93.01
100	3.5	2.5	12	98.41
100	4.0	3.0	12	100.62
100	4.5	3.5	12	104.17
100	5.0	4.0	12	107.17
100	6.0	4.0	12	125.60
100	10.0	7.0	12	244.15
125	1.5	1.0	16	104.17
125	2.0	1.3	16	95.31
125	2.5	1.5	16	93.01
125	3.0	2.0	16	93.01
125	3.5	2.5	16	98.41
125	4.0	3.0	16	100.62
125	4.5	3.5	16	104.17
125	5.0	4.0	16	107.17
125	6.0	4.0	16	125.60
125	6.5	4.0	16	136.64
125	12.0	8.0	16	328.59
140	3.0	2.0	18	97.53
150	1.5	1.0	18	109.47
150	2.0	1.3	18	99.68
150	2.5	1.5	18	97.59
150	3.0	2.0	18	97.59
150	3.5	2.5	18	103.60
150	4.0	3.0	18	105.92
150	4.5	3.5	18	109.47
150	5.0	4.0	18	114.34
150	6.0	4.0	18	132.06
150	8.0	6.0	18	186.41
150	10.0	7.0	18	255.04
150	12.0	8.0	18	399.82

D	B	b	z	£
180	1.5	1.0	18	112.34
180	2.0	1.3	18	103.60
180	2.5	1.5	18	100.62
180	3.0	2.0	18	100.62
180	3.5	2.5	18	106.47
180	4.0	3.0	18	109.47
180	4.5	3.5	18	112.34
180	5.0	4.0	18	116.17
180	6.0	4.0	18	136.10
180	6.5	4.0	18	147.85
180	8.0	6.0	18	217.34
180	10.0	8.0	18	285.47
200	1.5	1.0	18	116.17
200	2.0	1.3	18	106.47
200	2.5	1.5	18	103.60
200	3.0	2.0	18	103.60
200	3.5	2.5	18	110.17
200	4.0	3.0	18	112.34
200	4.5	3.5	18	116.17
200	5.0	4.0	18	119.95
200	6.0	4.0	18	140.47
200	10.0	8.0	18	382.83
200	12.0	8.0	18	578.75
225	4.0	3.0	18	123.54
225	4.5	3.5	18	128.03
225	5.0	4.0	18	133.68
225	6.0	4.0	18	155.22
225	7.0	4.0	18	188.54
250	4.5	3.5	20	183.35
250	5.0	4.0	20	186.37
250	6.0	4.0	20	186.37
250	8.0	6.0	20	227.74
280	4.0	3.0	22	188.99
280	6.0	4.0	22	203.40
300	6.0	4.0	24	233.93
300	8.0	6.0	24	422.34
300	10.0	8.0	24	482.95
100	4.0	2.8	6	27.35

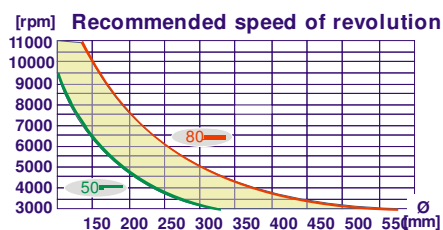

Biscuit
Jointers



Groove cutting saw blade for wood and boards. When grooving across the grain, use half the speed compared to along the grain.

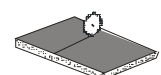



Saw blades for moulders

25AA25BO

The teeth have facet ground sides which result in a very smooth cutting surface. Oxide coated with a maximum cutting depth of 50mm.

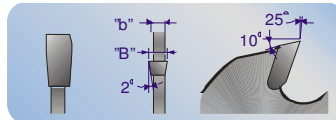

D	B	b	z	c	£
225	3.4	2.4	28	60	199.70
250	3.4	2.4	36	60	209.71

Feed Speed up to 150 m/min.

22/17AA15

The teeth have a special front grind (bevelled) for a better cutting results. Oxide coated with a maximum cutting depth of 30mm.

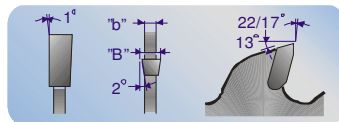

D	B	b	z	c	£
180	3.5	2.4	38	40/60	162.06
200	3.5	2.4	42	40/60	181.10
225	3.5	2.4	48	40/60	198.58
250	3.5	2.4	54	40/60	255.32

Feed Speed up to 150 m/min.

22AA19

Ripping in moulders with normal surface requirements. Maximum cutting depth 30mm.

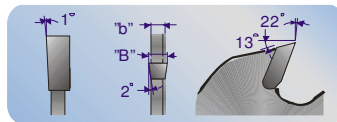

D	B	b	z	c	£
225	3.2	2.2	36	60	89.67
250	3.2	2.2	40	60	89.67

22AA26

Ripping in moulders with normal surface requirements. Maximum cutting depth 50mm

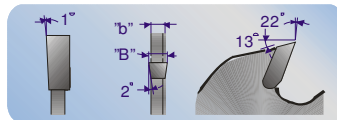

D	B	b	z	c	£
225	3.2	2.2	28	60	79.95
250	3.2	2.2	30	60	79.95

22AA39

Ripping in moulders with lower feed speed

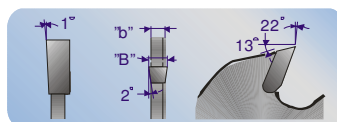

D	B	b	z	c	£
225	3.2	2.2	18	60	68.68
250	3.2	2.2	20	60	70.98

22AA39B2

Ripping in moulders with lower feed speed

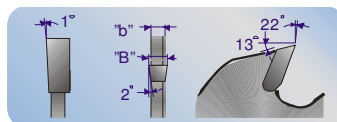

D	B	b	z	c	£
225	3.5	2.5	18	60	103.52
250	3.5	2.5	20	60	103.52

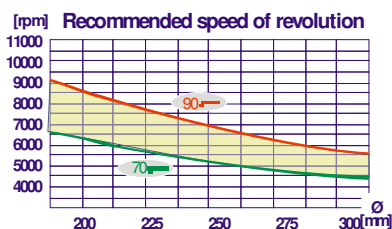

Blades for moulders. Some of these blades are "oxide coated"

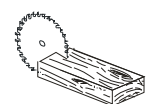

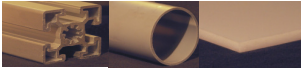

For Non-ferrous metals & Plastics

N2EAM6T3

Extra narrow cutting width and extremely close toothed. Intended for cutting very thin material.

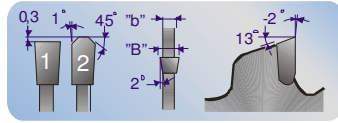

D	B	b	z	f
200	2.2	1.4	100	186.70
225	2.8	1.8	114	190.68
250	2.8	1.8	126	216.33
250	2.2	1.5	126	237.08
300	2.8	2.0	156	280.22
305	2.8	2.0	156	280.22

N2EAM8T3

Extra narrow cutting width and extremely close toothed. Intended for cutting very thin material.

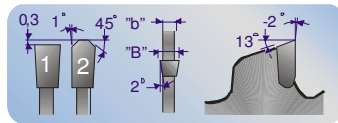

D	B	b	z	f
175	2.1	1.4	68	140.60
180	2.1	1.4	70	140.60
200	2.1	1.4	80	152.32
225	2.1	1.4	80	164.77
250	2.2	1.5	80	167.41
250	2.8	2.0	100	172.74
300	2.8	2.0	120	225.74

N2EAM10T3

Extra narrow cutting width and extremely close toothed. Intended for cutting very thin material.

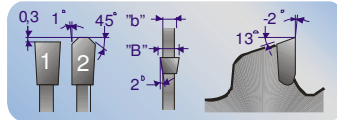

D	B	b	z	f
250	2.0	1.3	80	167.41

N2EAM08

Close toothed. Intended for cutting thin material.

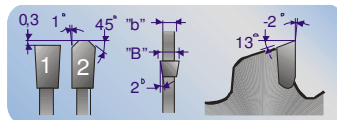

D	B	b	z	f
200	2.8	2.0	80	150.73
216	2.8	2.0	80	159.26
225	3.2	2.4	90	171.15
250	2.8	2.0	100	172.74
350	3.6	2.8	144	250.71
400	4.0	3.2	146	284.13

BLADE FACT

When cutting plastics the saw blade should be placed about 10-15 mm above the material.

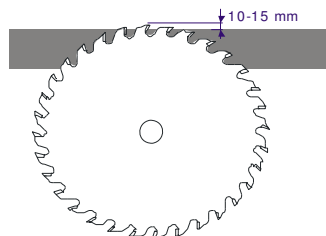

For thin, hard plastics we recommend alternately beveled teeth with chamfer (BAE).

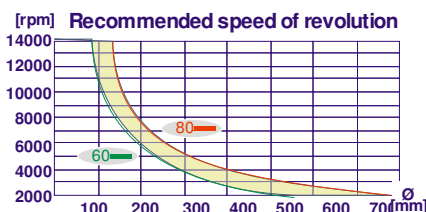

For Non-ferrous metals such as aluminium, copper and brass and also for plastics etc. Positive hook angle is used for automatic feed where the material is clamped and negative is used for manual feed.

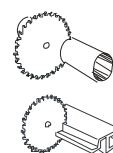

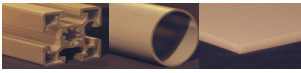

For Non-ferrous metals & Plastics

N2EAM10

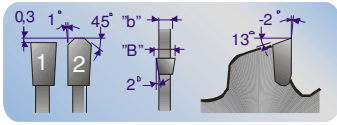

N2EAM13

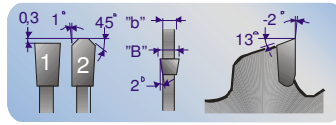

5EAM10

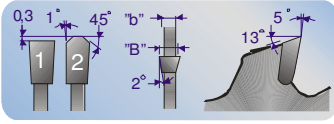

5EAM13

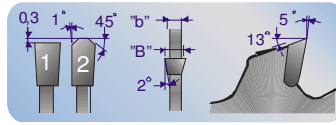

Close toothed for thin-walled metals & hard plastics

For cutting thin walled material with thickness up to approx. 10mm

D	B	b	z	f
102	2.8	2.0	32	103.62
125	2.8	2.0	40	103.62
160	2.8	2.0	48	103.62
180	2.8	2.0	56	114.60
190	2.8	2.0	60	122.12
200	2.8	2.0	64	122.12
210	2.8	2.0	64	133.21
216	2.8	2.0	64	133.21
220	3.2	2.4	64	144.30
225	3.2	2.4	72	144.30
230	3.2	2.4	72	144.30
250	3.2	2.4	80	144.30
260	3.2	2.4	80	157.19
275	3.2	2.4	84	160.54
280	3.2	2.4	88	182.83
300	3.2	2.4	96	182.83
305	3.2	2.4	96	182.83
330	3.6	2.8	104	198.41
350	3.6	2.8	108	198.41
370	4.0	3.2	116	227.76
380	4.0	3.2	116	227.76
400	4.0	3.2	120	227.76
420	4.0	3.2	132	290.85
450	4.0	3.2	144	290.85
500	4.0	3.2	160	299.81
550	4.4	3.4	172	587.20

D	B	b	z	f
102	2.8	2.0	24	99.68
125	2.8	2.0	32	99.68
150	2.8	2.0	36	99.68
160	2.8	2.0	36	99.68
180	2.8	2.0	42	105.65
200	2.8	2.0	48	113.16
210	2.8	2.0	48	114.60
216	2.8	2.0	48	114.60
225	3.2	2.4	56	128.84
230	3.2	2.4	56	128.84
250	3.2	2.4	60	128.84
260	3.2	2.4	60	140.61
275	3.2	2.4	64	140.61
300	3.2	2.4	72	153.94
330	3.6	2.8	80	176.10
350	3.6	2.8	84	176.10
370	4.0	3.2	90	208.05
380	4.0	3.2	90	208.05
400	4.0	3.2	96	208.05
420	4.0	3.2	100	253.75
450	4.0	3.2	108	253.75
500	4.0	3.2	120	283.44
520	4.4	3.4	120	460.90
530	4.4	3.4	128	460.90
550	4.4	3.4	132	460.90
600	4.4	3.4	144	472.78
650	4.4	3.4	160	689.11

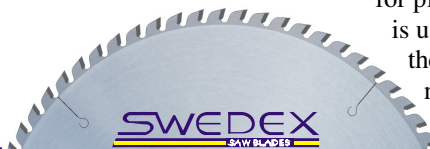
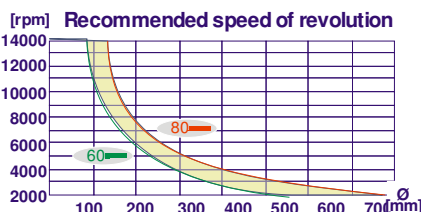

For Non-ferrous metals such as aluminium, copper and brass and also for plastics etc. Positive hook angle is used for automatic feed where the material is clamped and negative is used for manual feed.

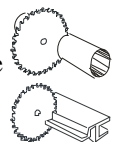



For Non-ferrous metals & Plastics

N2EAM16

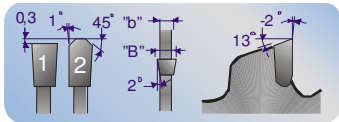

N2EAM19

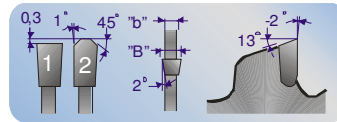

5EAM16

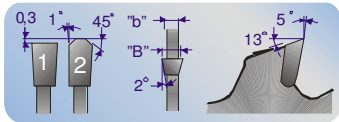

7EAM19

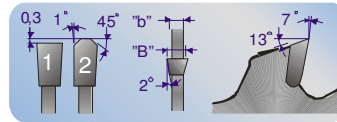

For solid metal and profiles with Material thickness up to approx. 15mm

For solid metal and profiles with material thickness above approx. 10mm.

D	B	b	z	£
102	2.8	2.0	20	99.68
160	2.8	2.0	30	99.68
180	2.8	2.0	36	105.65
200	2.8	2.0	40	113.16
250	3.2	2.4	50	128.84
275	3.2	2.4	54	140.61
300	3.2	2.4	60	153.94
330	3.6	2.8	64	176.10
350	3.6	2.8	70	176.10
370	4.0	3.2	76	208.05
400	4.0	3.2	80	208.05
420	4.0	3.2	84	253.75
450	4.0	3.2	90	253.75
500	4.0	3.2	100	283.44
550	4.4	3.4	108	460.90
600	4.4	3.4	120	472.78

D	B	b	z	£
200	2.8	2.0	32	94.11
216	2.8	2.0	32	104.98
225	3.2	2.4	36	121.34
250	3.2	2.4	40	121.34
275	3.2	2.4	44	136.80
300	3.2	2.4	48	142.84
330	3.6	2.8	54	167.16
350	3.6	2.8	56	167.16
370	4.0	3.2	60	185.75
400	4.0	3.2	64	185.75
420	4.0	3.2	68	237.52
450	4.0	3.2	72	237.52
500	4.0	3.2	80	255.44
550	4.4	3.4	90	419.91
600	4.4	3.4	96	431.78
650	4.4	3.4	108	656.86
700	4.4	3.4	116	712.95

27EAM30B2

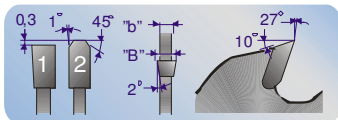

For solid aluminium ingots. Minimum material thickness 25mm.

D	B	b	z	£
300	4.0	2.6	30	174.76
400	4.4	3.0	40	214.93
450	5.0	3.6	44	264.42
500	5.0	3.6	50	283.33
550	5.0	3.6	56	397.72
600	5.0	3.6	60	403.93
650	5.5	4.0	68	524.17
700	5.5	4.0	72	606.15

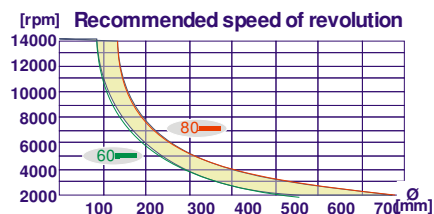

For Non-ferrous metals such as aluminium, copper and brass and also for plastics etc. Positive hook angle is used for automatic feed where the material is clamped and negative is used for manual feed.

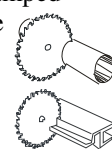
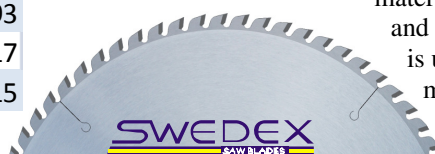



blades for Non-ferrous metals

The 'Highline' blades for non-ferrous metals are used when the demand for quality, function and performance is paramount. The 'Highline' blade with its optimised variable pitch geometry and reduced noise levels through its dampened slits and finish allows the blade to operate at a higher rpm and to accept larger lateral loads. It is suitable for non-ferrous metals, plastic, aluminium, copper, brass etc.

H5EAM10

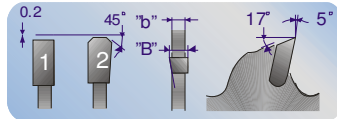

Close-toothed saw blade for thin walled metals and hard plastics. Maximum material thickness 7mm. Positive rake angle.

D	B	b	z	£
370	4.0	3.2	114	341.56
400	4.0	3.2	120	341.56
420	4.0	3.2	132	436.12
450	4.0	3.2	144	436.12
500	4.0	3.2	160	444.91

H5EAM13

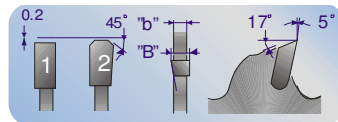

Saw blade for cutting profiles and solid aluminium. Material thickness up to 13mm. Positive rake angle.

D	B	b	z	£
370	4.0	3.2	90	312.03
400	4.0	3.2	96	312.03
420	4.0	3.2	100	380.57
450	4.0	3.2	108	380.57
500	4.0	3.2	120	425.09
550	4.4	3.4	132	691.30
600	4.4	3.4	144	691.30

H5EAM16

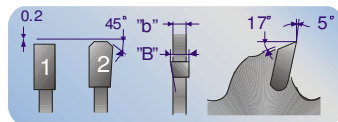

Saw blade for cutting profiles and solid aluminium. Material thickness up to 20mm. Positive rake angle.

D	B	b	z	£
370	4.0	3.2	76	312.03
400	4.0	3.2	80	312.03
420	4.0	3.2	84	380.57
450	4.0	3.2	90	380.57
500	4.0	3.2	100	425.09
550	4.4	3.4	108	691.30
600	4.4	3.4	120	691.30

H7EAM19

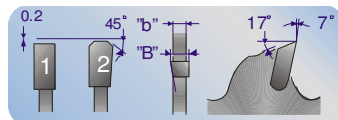

Saw blade for cutting solid aluminium. Maximum material thickness up to 30mm. Positive rake angle.

D	B	b	z	£
370	4.0	3.2	60	289.25
400	4.0	3.2	64	289.25
420	4.0	3.2	68	356.21
450	4.0	3.2	72	356.21
500	4.0	3.2	80	383.10
550	4.4	3.4	90	629.72
600	4.4	3.4	96	629.72

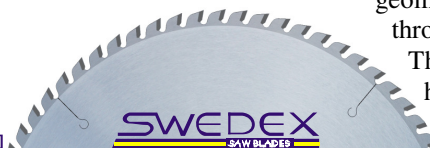
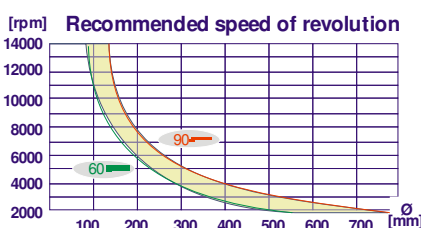

Blade for non-ferrous metals. The blade has an optimised variable pitch geometry and reduced noise levels through dampened slits and finish. The blade can operate at a higher than usual rpm and can accept larger lateral loads. For Non-ferrous and plastics

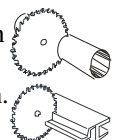

Special blades for window/UPVC industry

N2AAM6 Elumatec
N2AAM9 V-notch

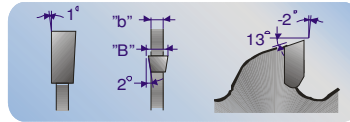

D	B	b	z	£
200	2.2	1.4	100	186.70
250	2.2	1.5	126	237.08
400	4.0	3.2	146	284.13

5AAM8 V-notch
as above

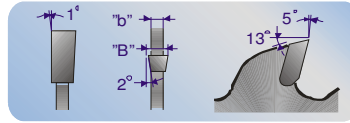

D	B	b	z	£
254	3.4	2.6	100	232.54

N5CA/DA10 AND
N5CA/DA15 Trim saw
blades

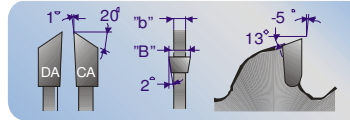

D	B	b	z	£
95	2.0	1.4	20	95.01
98	2.0	1.4	30	109.73
103	2.0	1.4	24	109.73
103	2.0	1.4	42	114.58
113.4	2.25	1.4	30	120.06

N2EAM8 Haffner
machines

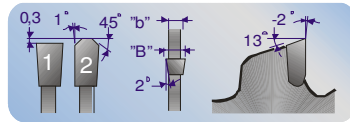

D	B	b	z	£
175	2.1	1.3	68	140.60
180	2.1	1.3	70	140.60

7EAM19sp Emmegi
machines

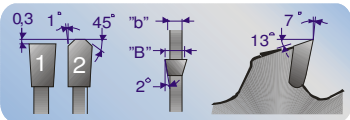

D	B	b	z	£
650(40mmBore)	5.0	4.4	108	847.50

10EAM24 Bombastic
machines

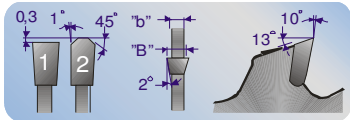

D	B	b	z	£
500	4.4	3.9	66	319.38

10BA10 Janser m/c
c/sunk bore

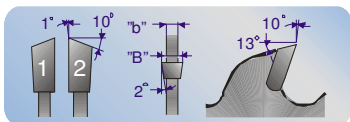

D	B	b	z	£
160	1.6	2.0	48	103.08

BLADE FACT

When cutting plastics the saw blade should be placed about 10-15 mm above the material.

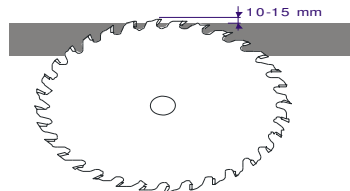

For thin, hard plastics we recommend alternately beveled teeth with chamfer (BAE).



6BAE10 For Corian &
N5BAE10 Hard plastics

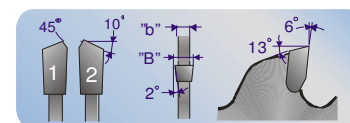

For N5BAE10 hook angle should be -5*

D	B	b	z	£
250	3.2	2.2	80	122.59
300	3.2	2.2	96	141.53
350	3.5	2.5	112	173.86



Radius tip blades for the window industry

N5AAR25

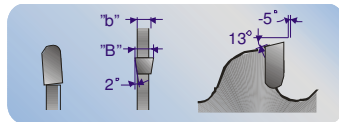

D	B	b	z	£
180	5.0	4.0	24	255.77
200	5.0	4.0	24	267.53
250	5.0	4.0	32	305.61
250	5.0	4.0	64	595.67

Full radius tips for Urban and Haffner corner cleaners

N2AAMR10

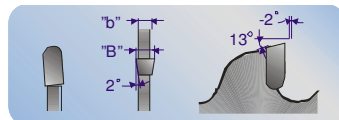

D	B	b	z	£
230	3.2	2.4	72	294.74

Full radius tips for Elumatic corner cleaners etc.

5AAR27

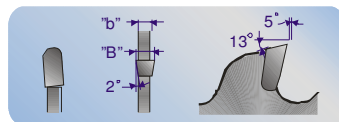

D	B	b	z	£
170	4.5	3.1	20	531.51
190	4.5	3.1	22	557.06

The tips have radius corners for Rotox machines

BLADE FACT

The steel used in our saw blades is of the highest quality. It is a spring steel hardened to give the saw body additional strength and stability.

The steel is laser cut and thereafter tempered to receive the correct hardness, depending on the application and use of the saw blade.

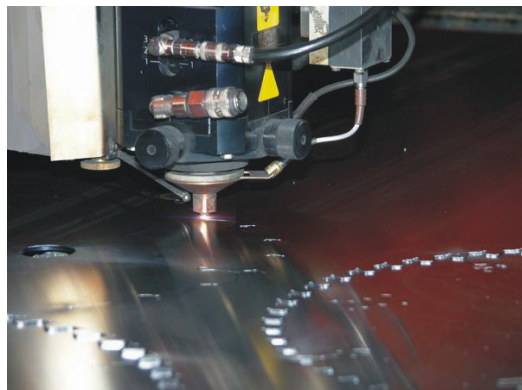

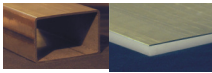

Steel cutting saw blades

Dry cut blades equipped with special carbide tips suitable for sawing steel without cooling.

S13 125-230mm

For cutting mild steel

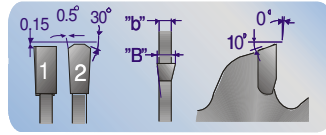

D	B	b	z	£
136	2.2	1.6	36	93.26
150	2.0	1.6	36	100.22
160	2.0	1.6	36	100.22
160	2.2	1.6	62	145.32
165	2.2	1.6	36	102.63
180	2.0	1.6	42	107.16
200	2.0	1.6	48	114.62
210	2.0	1.6	50	122.84
216	2.0	1.6	48	116.03
230	2.0	1.6	54	130.39
230	2.0	1.6	72	152.50
250	2.2	1.8	60	130.39
250	2.2	1.8	80	162.40
305	2.2	1.8	60	133.44
305	2.2	1.8	80	164.13
355	2.6	2.2	84	178.50
400	3.5	2.8	96	216.39
450	3.8	3.1	96	264.16
500	4.2	3.5	96	295.13
550	4.4	3.6	96	503.40
600	4.4	3.6	96	542.28
700	4.4	3.6	116	862.60

S13 250-700mm

For cutting mild steel

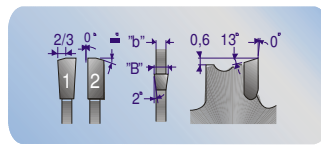

D	B	b	z	£
160	2.2	1.6	62	145.32
200	2.2	1.6	64	150.48
230	2.0	1.6	72	152.50
250	2.2	1.8	80	162.40
305	2.2	1.8	80	164.13
355	2.6	2.2	84	178.50

S13 Stainless

Positive hook angle designed for cutting stainless steel

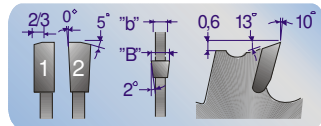

D	B	b	z	£
350	3.2	2.5	84	197.30
400	3.2	2.5	96	241.33
450	4.0	3.2	108	293.01
500	4.0	3.2	120	366.03

N6EA13sp

Special grind for cutting thin-walled sheets of sandwich material (steel/foam etc.)

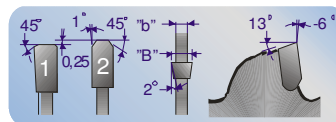

Our S13s are Dry cut blades for cutting steel without cooling. Steel is very abrasive and consequently

resharpening should be done on a regular basis. These blades are suitable for sheet-metal workers, plumbers and for use in machine shops. Can also be used on a portable saw.

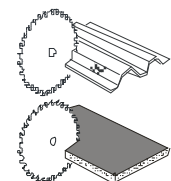

Page

29

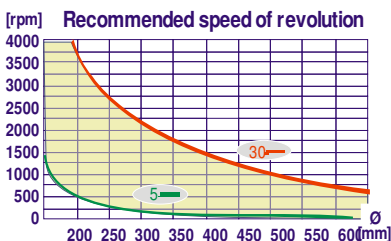

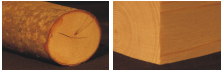

Blades for the Sawmill industry

NOTE

We supply and manufacture sawblades for almost any application on almost any type of machine. Among the most popular being Söderhamn, Ari/Vislanda, Ari/Heinola, Iggesund, Linck, EWD, SAB, Catech, Ahlström and Hew saw.

If you require any advise or a quote for your particular needs, them please contact a member of our technical staff.





HSS (High Speed Steel) saw blades

SHSS for mild steel

DIN 1,3343 DM05 Steam Oxide Finish For Cutting Mild Steel

D	b	c	z	£
180	2.0	32	180	64.08
200	1.8	32	200	64.08
200	1.8	32	160	64.08
225	2.0	32	220	67.30
225	2.0	32	180	67.30
250	2.0	32	250	76.32
250	2.0	32/40	200	76.32
250	2.0	32/40	180	76.32
250	2.0	32/40	160	76.32
250	2.0	32	128	76.32
250	2.0	32	BLK	70.43
275	2.0	32	220	100.35
275	2.0	32	180	100.35
275	2.0	32	160	100.35
275	2.0	32	BLK	92.74
275	2.5	32/40	220	104.40
275	2.5	32/40	180	104.40
275	2.5	32/40	160	104.40
275	2.5	32/40	BLK	96.44

D	b	c	z	£
300	2.0	32	220	123.37
300	2.0	32	180	123.37
300	2.0	32	160	123.37
300	2.0	32	BLK	113.71
300	2.5	32/40	220	126.11
300	2.5	32/40	180	126.11
300	2.5	32/40	160	126.11
300	2.5	32/40	BLK	116.34
315	2.0	32/40	220	134.52
315	2.0	32/40	180	134.52
315	2.0	32/40	160	134.52
315	2.0	32/40	BLK	124.09
315	2.5	32/40	220	135.03
315	2.5	32	200	135.03
315	2.5	32/40	180	135.03
315	2.5	32/40	160	135.03
315	2.5	32/40	BLK	124.55
350	2.5	32	280	172.59
350	2.5	32	220	172.59
350	2.5	32	180	172.59
350	2.5	32	160	172.59
350	2.5	32	BLK	159.38

SHSS for stainless steel

Extreme TI-ALN
For Cutting Mild Steel

D	b	c	z	£
275	2.0	32	220	147.89
275	2.0	32	180	147.89
300	2.5	32	220	178.90
200	2.5	32	180	178.90
315	2.5	32	220	193.88
315	2.5	32	180	193.88
350	2.5	32	280	255.24
350	2.5	32	220	255.24

SHSS Low Rockwell

Low Rockwell Blades for the
Window Industry

D	b	c	z	£
250	2.0	32	200	106.02

SHSS Trim Blades

Supplied 45 deg Left & Right Hand

D	b	c	z	£
103	2.0	32	60	74.91

Swedex are the UK agents for GLG,
Spain's premier manufacturer of SHSS
saw blades.





Hobby Blades

Professional Hard Body Saw Blades

Wood cutting ATB

D	B	b	c	z	£
110	2.0	1.4	20	20	18.42
128	2.6	1.6	20	14	13.56
130	2.6	1.6	20	24	16.95
140	2.6	1.6	16	16	14.43
150	2.6	1.6	20	24	17.27
150	2.6	1.6	20	40	25.51
160	2.6	1.6	20	16	15.25
160	2.6	1.6	20	50	27.35
165	2.6	1.6	30	18	16.95
165	2.6	1.6	20	50	25.51
180	2.6	1.6	30	20	18.94
180	2.6	1.6	30	40	25.74
184	2.6	1.6	16/30	24	21.36
184	2.6	1.6	16/30	40	25.85
184	2.6	1.6	16/30	60	32.11
190	2.6	1.6	16/30	24	23.82
190	2.6	1.6	16/30	40	28.38
200	2.6	1.6	30	24	26.27
200	2.6	1.6	30	40	28.38
210	2.6	1.6	30	20	28.38
210	2.6	1.6	30	40	28.38
230	2.8	1.8	30	40	36.93
235	2.8	1.8	30	30	29.31
235	2.8	1.8	30	40	38.29
235	2.8	1.8	30	60	45.92
250	2.8	1.8	30	24	36.62
250	2.8	1.8	30	40	41.51
250	2.8	1.8	30	60	52.28
250	2.8	1.8	30	80	59.63
260	2.8	1.8	30	30	44.58
260	2.8	1.8	30	60	57.17
300	2.8	1.8	30	48	69.49
305	2.8	1.8	30	40	73.25

Steel cutting

D	B	b	c	z	£
180	2.2	2.0	20	36	50.65
230	2.2	1.8	30	54	90.35

Nail resistant(Flat top)

D	B	b	c	z	£
184	2.2	1.6	16	14	14.13
190	2.2	1.6	16	14	15.92

Chop Saw Blades

D	B	b	c	z	£
205	2.6	1.8	18	24	33.72
210	2.6	1.8	30	48	44.22
216	2.8	2.0	30	24	35.43
216	2.8	2.0	30	48	45.92
216	2.8	2.0	30	60	55.06
250	2.8	2.0	30	80	64.71
254	2.8	2.0	30	40	58.32
254	2.8	2.0	30	60	67.34

Aluminium & Plastic (Triple Chip)

D	B	b	c	z	£
184	2.2	1.6	16	48a	37.78
200	2.2	1.6	30	60a	49.99
210	2.2	1.6	30	48a	45.92
216	2.4	1.8	30	48a	47.60
216	2.4	1.8	30	60a	59.30
216	2.4	1.8	30	80a	61.52
250	2.8	2.2	30	80a	65.05
260	2.8	2.2	30	60a	62.25

Cordless machines

D	B	b	c	z	£
85	1.6	1.0	10	20	22.49
136	1.6	1.0	10	24	23.40
150	1.6	1.0	10	24	24.24
165	1.6	1.0	10/20	24	24.98
165	1.6	1.0	10	52	26.68
190	1.6	1.0	30	24	28.62

Cordless machines-Steel

D	B	b	c	z	£
136	1.5	1.0	10	30	64.08
165	1.5	1.0	10	40	80.41

A range of saw blades for use with portable saws.





Other Cutting Tools

Angle grinder Super System

A range of blades for use on an angle grinder. These blades are designed to be used with a special protective guard, which is also available from stock.

	D	B	b	c	z	£
Steel	125	2.2	1.6	25.4	24	75.64
	115	2.2	1.6	25.4	24	68.33
Wood	125	2.5	1.5	25.4	12	57.44
	115	2.5	1.5	25.4	12	52.68
Carver	125	4.0	2.5	25.4	6	59.01
	115	4.0	2.5	25.4	6	54.22
Guards	115/125					73.95

Router Cutters

2 Flute Plunge router cutters

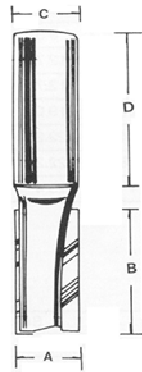

Cutting Dia	Cutting Length	Shank Dia	Shank Length	£
A	B	C	D	
1/2"	2"	1/2"	35mm	22.57
1/2"	1.1/14"	1/2"	35mm	19.66

Mortice Chisel & bit Sets

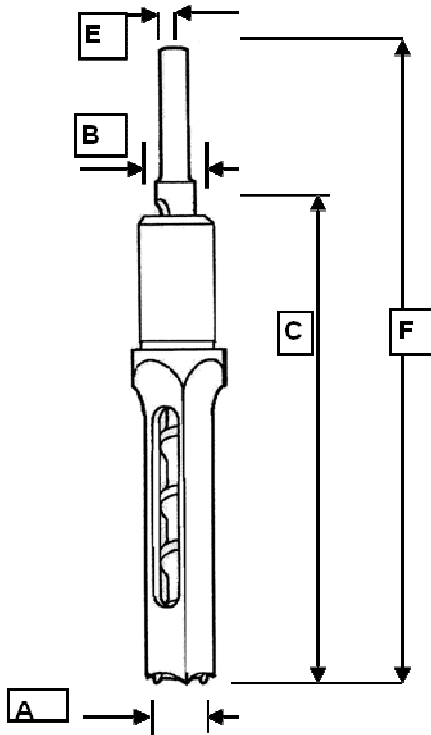

Size A	B	C	E	F	£
1/4"	20.6	133	4.4	210	42.36
5/16"	20.6	138	5.9	210	42.36
3/8"	20.6	138	7.0	210	42.36
7/16"	20.6	138	8.4	210	46.29
1/2"	20.6	138	9.4	210	46.29
9/16"	20.6	156	10.5	225	53.73
5/8"	20.6	156	11.9	225	53.73
3/4"	20.6	163	11.9	240	76.94
1"	30.1	190	12.5	275	141.90

